

1. Part No. Expression

PIAQ 1004 S R15 Y N

(a) (b) (c) (d) (e) (f)

- (a) Series Code
- (b) Dimension Code
- (c) Material Code
- (d) Inductance Code
- (e) Tolerance Code
- (f) Special Code

2. Configuration & Dimensions (Unit: mm)

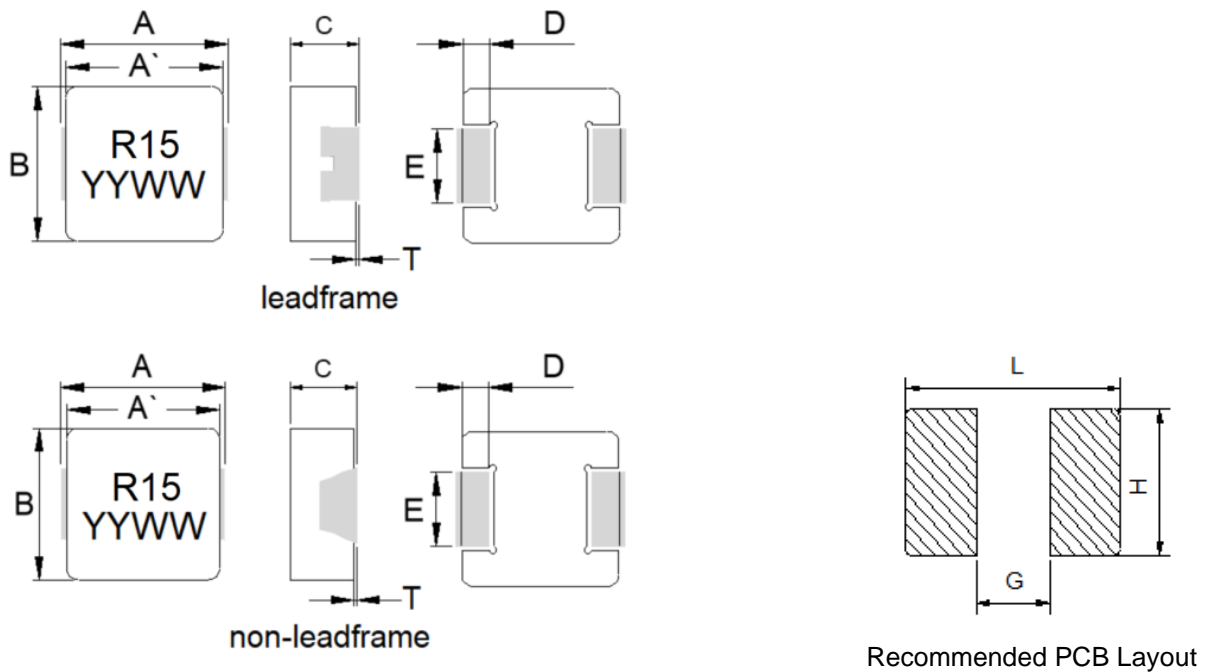

- Note:
1. The above PCB layout reference only.
 2. Recommend solder paste thickness at 0.15 mm and above.
 3. Marking: Top= Inductance Code, Bottom=YYWWV (Year/World week), Black

| Inductance | A | A' | B | C | D | E | T | L | G | H |
|-------------------|----------|----------|----------|---------|---------|---------|---------|----------|---------|---------|
| 0.56~1.50uH among | 11.0±0.3 | 10.0±0.3 | 10.0±0.3 | 3.8±0.2 | 2.0±0.3 | 2.5±0.3 | 0.0~0.2 | 12.5 Ref | 5.4 Ref | 3.5 Ref |
| 0.47uH and below | | | | | | 3.0±0.3 | | | | |
| 2.20uH and above | | | | | | 3.0±0.3 | | | | |

NOTE: Specifications subject to change without notice. Please check our website for latest information.

3. Schematic

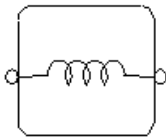

4. Material List

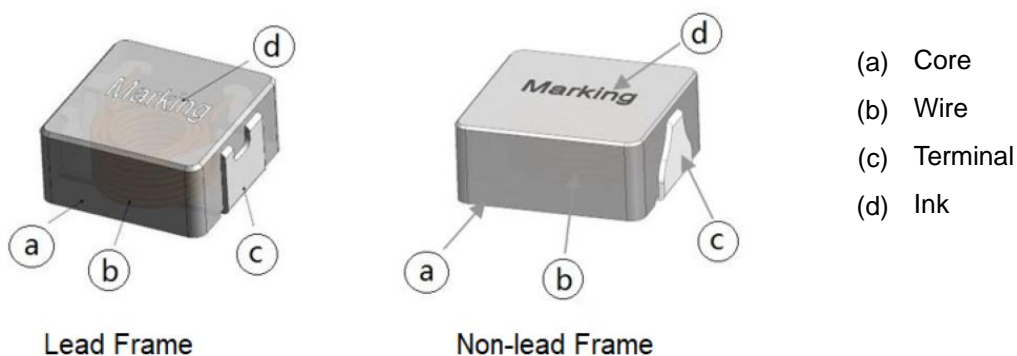

5. General Specifications

- (a) Reliability test for this part meets AEC-Q200 standard.
- (b) Operating Temp.: -55°C to +155°C (including self-temperature rise)
- (c) Storage Temp.: -55°C to +155°C (on board)
- (d) All test data referenced to 25°C ambient.
- (e) Heat Rated Current (I_{rms}) will cause the coil temperature rise approximately ΔT of 40°C. (keep 1min)
- (f) Saturation Current (I_{sat}) will cause inductance L₀ to drop approximately 30%.
- (g) Rated Current: The lower value of I_{sat} and I_{rms}.
- (h) Part Temperature (Ambient + Temp. Rise): Should not exceed 155°C under worst case operating conditions.
- (i) Maximum Operating Voltage: 75V
- (j) Storage Condition (Component in its packaging)
 - i) Temperature: Less than 40°C
 - ii) Humidity: Less than 60% RH

NOTE: Specifications subject to change without notice. Please check our website for latest information.

6. Electrical Characteristics

| Part Number | Inductance Lo (uH) @ 0A | I _{rms} (A) | | I _{sat} (A) | | DCR (mΩ) | | Type |
|----------------|-------------------------------|-------------------------|------|-------------------------|------|-------------|------|----------------|
| | | Typ | Max | Typ | Max | Typ | Max | |
| PIAQ1004SR15YN | 0.15 | 44 | 38 | 82 | 75 | 0.5 | 0.6 | Non lead frame |
| PIAQ1004SR22MN | 0.22 | 36 | 33 | 70 | 60 | 0.72 | 0.83 | Non lead frame |
| PIAQ1004SR36MN | 0.36 | 33 | 29 | 51 | 45 | 1.05 | 1.18 | Non lead frame |
| PIAQ1004SR42MN | 0.42 | 32.5 | 28.5 | 50 | 42 | 1.15 | 1.3 | Non lead frame |
| PIAQ1004SR47MN | 0.47 | 32 | 28 | 46 | 40 | 1.3 | 1.5 | Non lead frame |
| PIAQ1004SR56MN | 0.56 | 25 | 23 | 34 | 29 | 1.6 | 1.8 | Non lead frame |
| PIAQ1004SR68MN | 0.68 | 23 | 20 | 31 | 28 | 1.9 | 2.2 | Non lead frame |
| PIAQ1004S1R0MN | 1.00 | 20 | 18 | 29 | 26 | 2.9 | 3.25 | Non lead frame |
| PIAQ1004S1R5MN | 1.50 | 17.5 | 16 | 26 | 22 | 3.7 | 4.2 | Non lead frame |
| PIAQ1004S2R2MN | 2.20 | 15 | 13 | 20 | 16 | 5.8 | 6.7 | Lead frame |
| PIAQ1004S3R3MN | 3.30 | 11 | 10 | 17.5 | 14 | 10.5 | 11.8 | Lead frame |
| PIAQ1004S4R7MN | 4.70 | 8.8 | 8.0 | 15.2 | 13 | 15.8 | 19 | Lead frame |
| PIAQ1004S5R6MN | 5.60 | 8.0 | 7.2 | 14.1 | 11.5 | 19 | 22.8 | Lead frame |
| PIAQ1004S6R8MN | 6.80 | 7.8 | 6.8 | 12.2 | 11 | 22 | 24.5 | Lead frame |
| PIAQ1004S8R2MN | 8.20 | 7.6 | 6.5 | 9.5 | 8.5 | 25 | 28 | Lead frame |
| PIAQ1004S100MN | 10.0 | 7.5 | 6.1 | 8.6 | 7.5 | 27 | 30 | Lead frame |
| PIAQ1004S150MN | 15.0 | 6.25 | 5.0 | 7.0 | 6.0 | 41 | 45 | Lead frame |
| PIAQ1004S220MN | 22.0 | 5.0 | 4.1 | 6.2 | 5.5 | 58 | 66 | Lead frame |
| PIAQ1004S330MN | 33.0 | 4.4 | 3.5 | 5.5 | 5.0 | 84 | 91 | Lead frame |
| PIAQ1004S470MN | 47.0 | 3.5 | 3.0 | 4.0 | 3.7 | 125 | 143 | Lead frame |
| PIAQ1004S680MN | 68.0 | 2.6 | 2.4 | 3.2 | 3.0 | 184 | 210 | Lead frame |
| PIAQ1004S820MN | 82.0 | 2.3 | 2.1 | 3 | 2.8 | 240 | 270 | Lead frame |
| PIAQ1004S101MN | 100.0 | 2.0 | 1.8 | 2.7 | 2.4 | 270 | 310 | Lead frame |

Note:

Tolerance code: M = ±20%, Y = ±30%

Test Frequency: 1.0V/100KHz

NOTE: Specifications subject to change without notice. Please check our website for latest information.

7. Characteristics Curve

PIAQ1004SR15YN

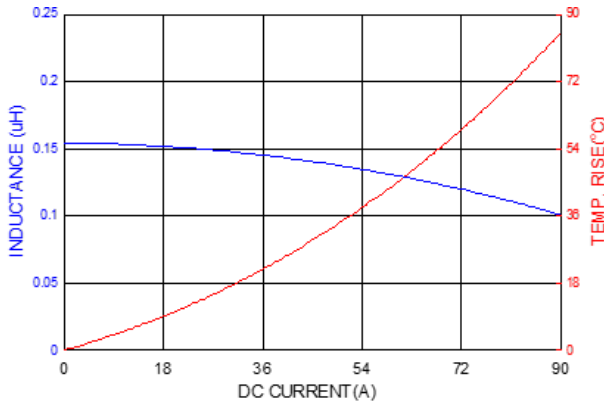

PIAQ1004SR22MN

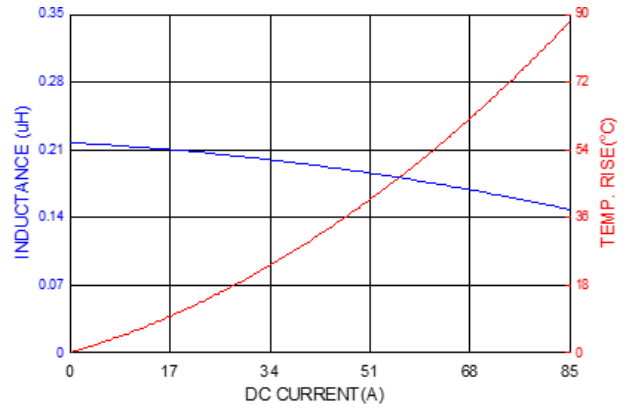

PIAQ1004SR36MN

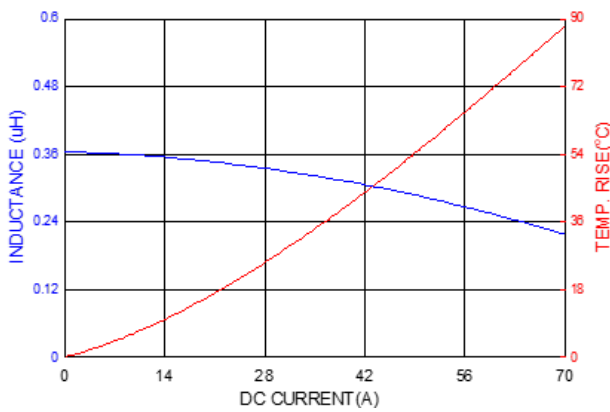

PIAQ1004SR42MN

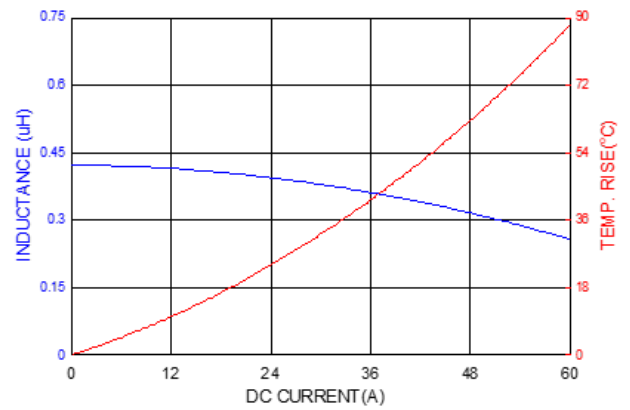

PIAQ1004SR47MN

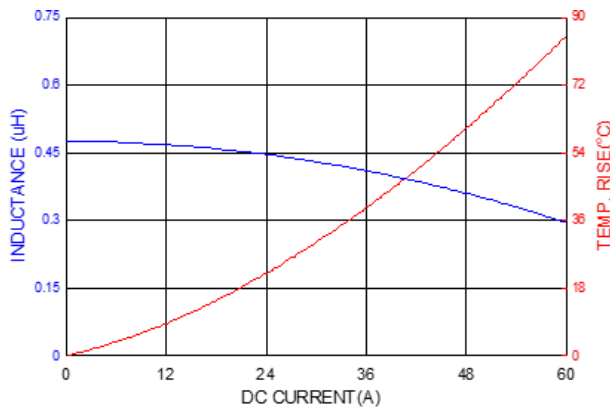

PIAQ1004SR56MN

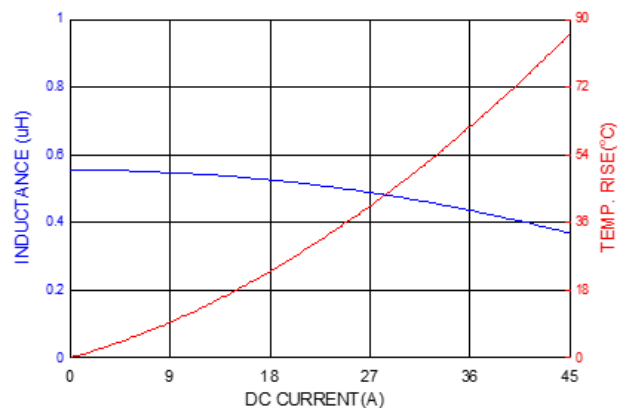

NOTE: Specifications subject to change without notice. Please check our website for latest information.

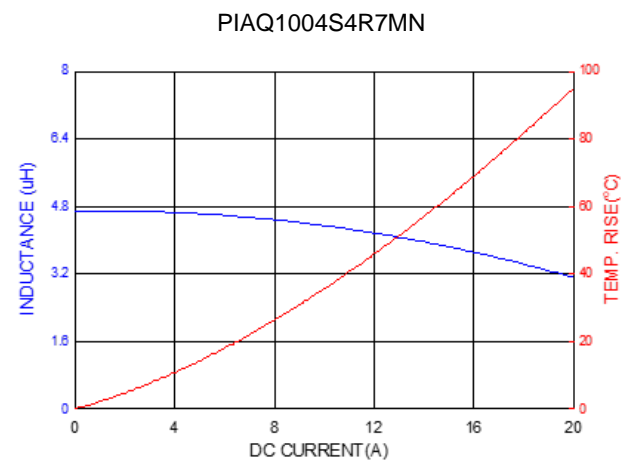
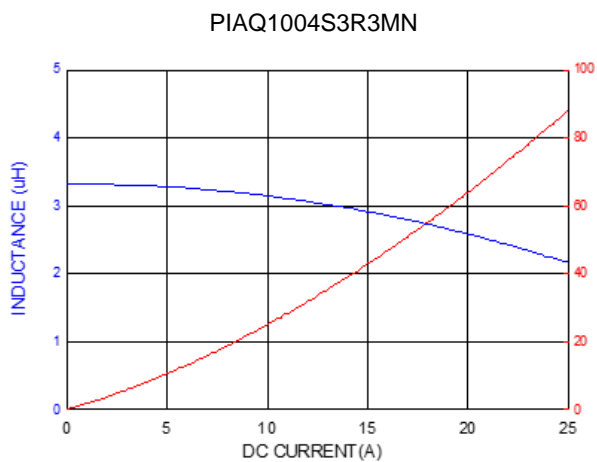
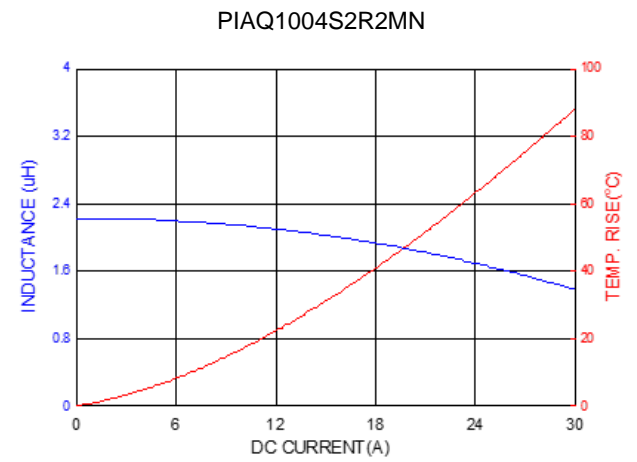
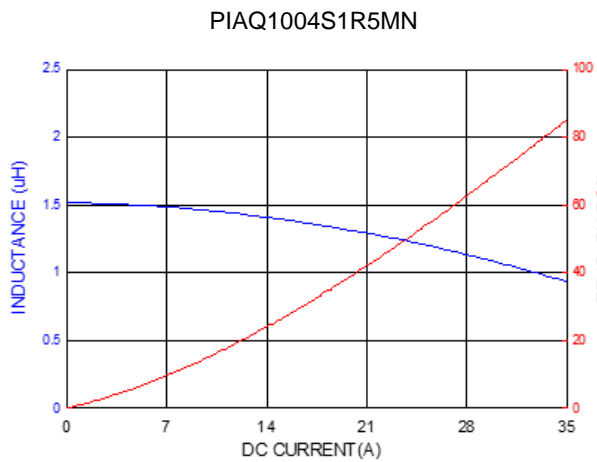
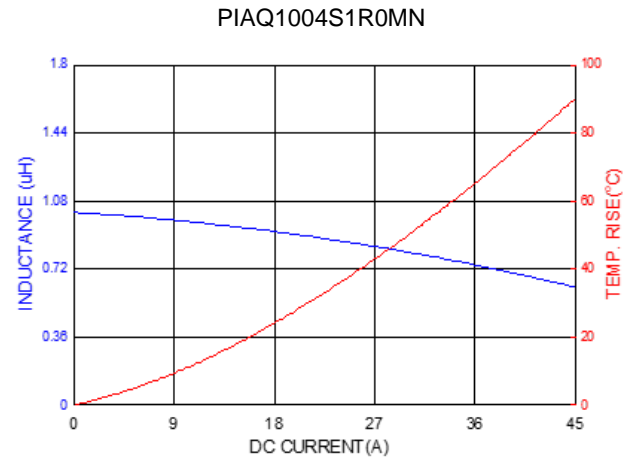
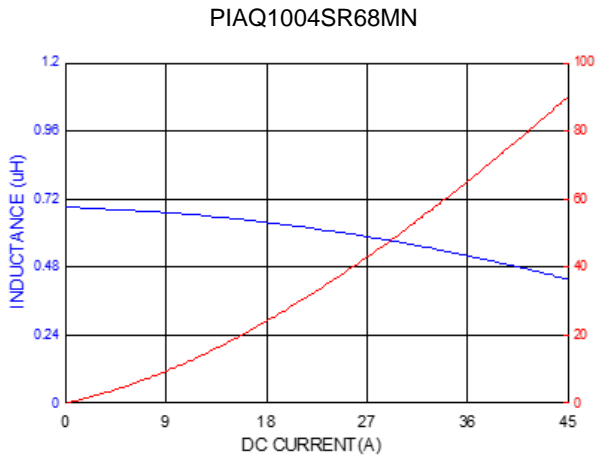

NOTE: Specifications subject to change without notice. Please check our website for latest information.

PIAQ1004S5R6MN

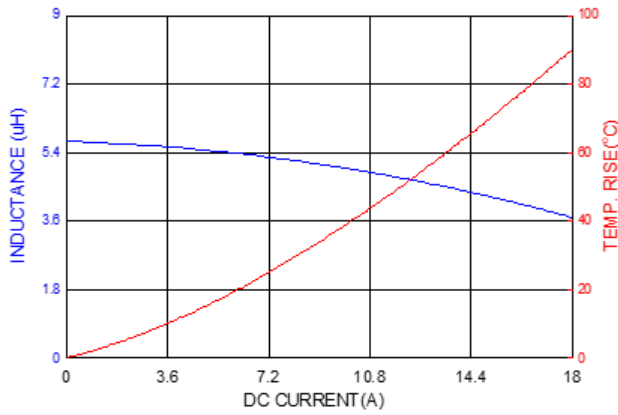

PIAQ1004S6R8MN

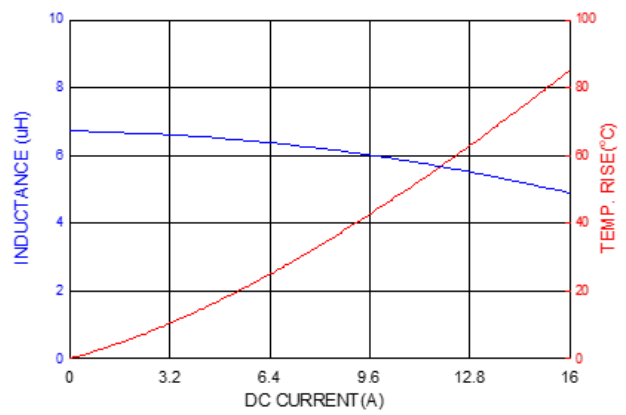

PIAQ1004S8R2MN

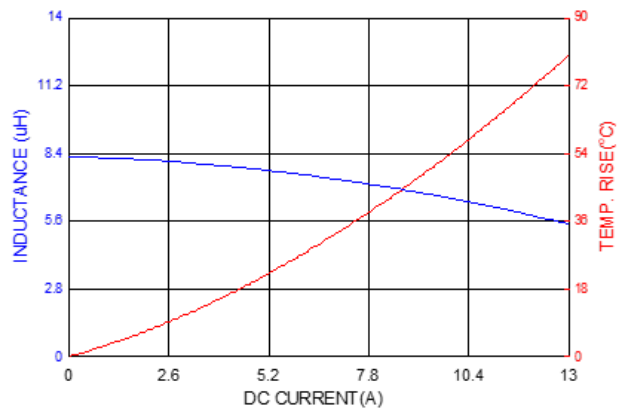

PIAQ1004S100MN

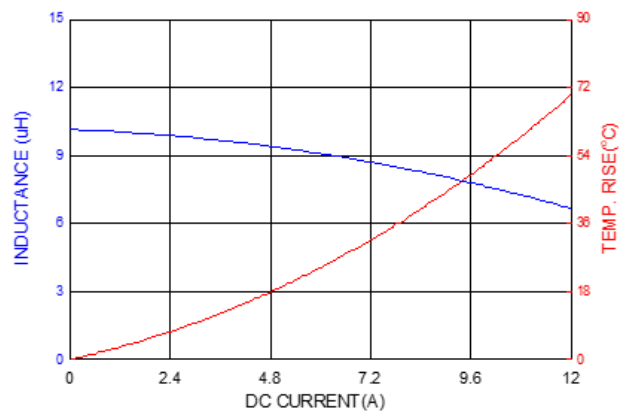

PIAQ1004S150MN

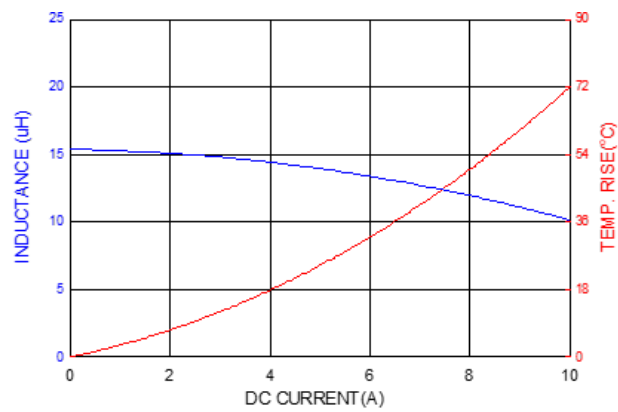

PIAQ1004S220MN

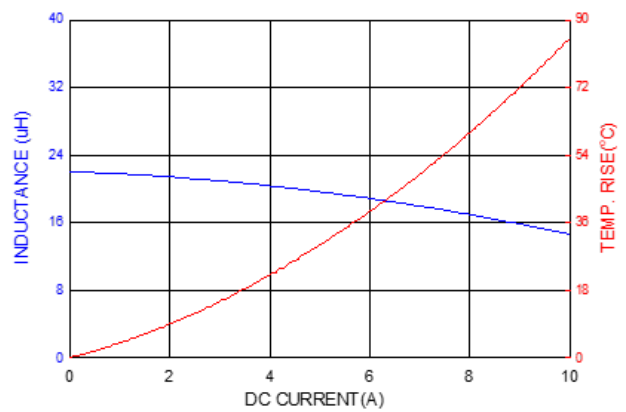

NOTE: Specifications subject to change without notice. Please check our website for latest information.

PIAQ1004S330MN

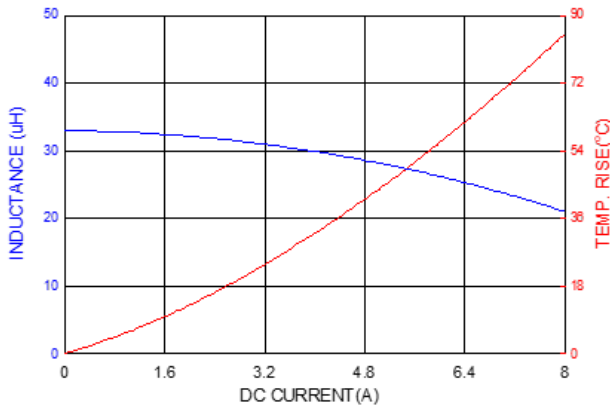

PIAQ1004S470MN

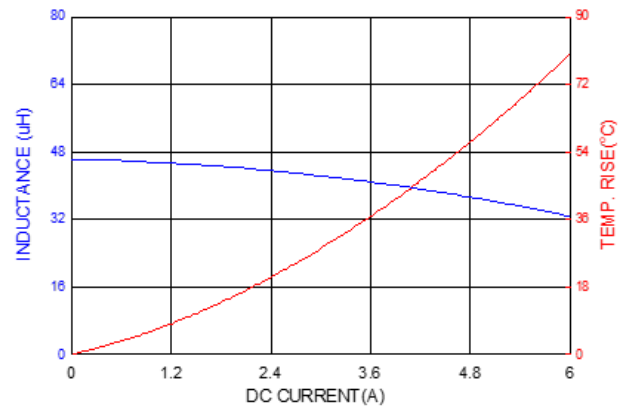

PIAQ1004S680MN

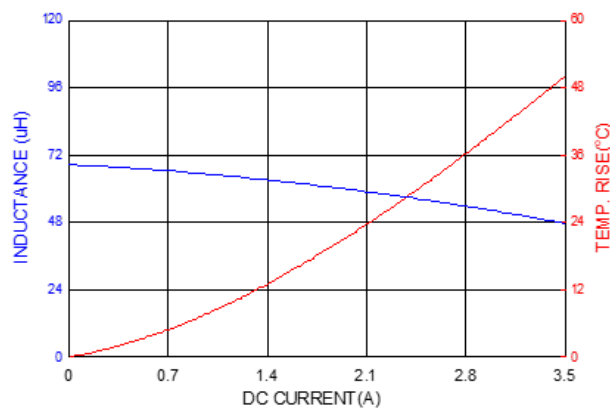

PIAQ1004S820MN

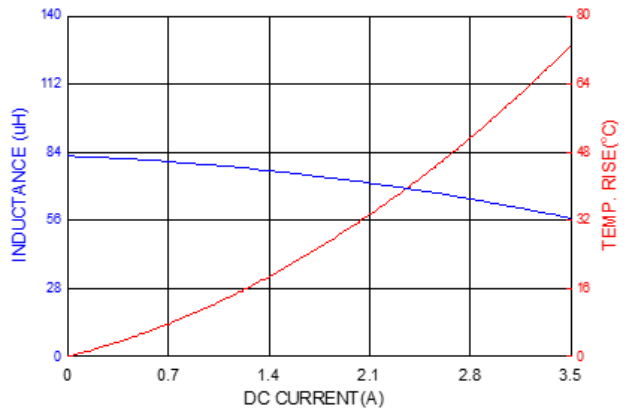

PIAQ1004S1011MN

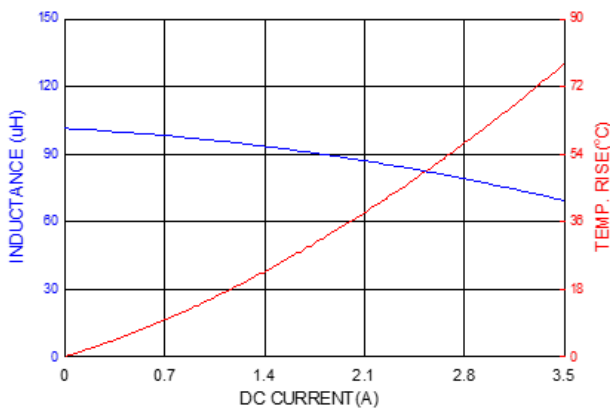

NOTE: Specifications subject to change without notice. Please check our website for latest information.

8. Soldering Specification

Mildly activated rosin fluxes are preferred. Our terminations are suitable for re-flow soldering systems. If hand soldering cannot be avoided, the preferred technique is the utilization of hot air soldering tools.

8-1. IR Soldering Reflow

Recommended temperature profiles for lead free re-flow soldering in Figure 1, Table 1.1 & 1.2 (J-STD-020E).

8-2. Iron Reflow

Products attachment with a soldering iron is discouraged due to the inherent process control limitations. In the event that a soldering iron must be employed the following precautions are recommended (Figure 2).

Note:

- (a) Preheat circuit and products to 150°C.
- (b) 355°C tip temperature (Max.)
- (c) Never contact the ceramic with the iron tip
- (d) 1.0mm tip diameter (Max.)
- (e) Use a 20 watt soldering iron with tip diameter of 1.0mm
- (f) Limit soldering time to 4~5 sec.

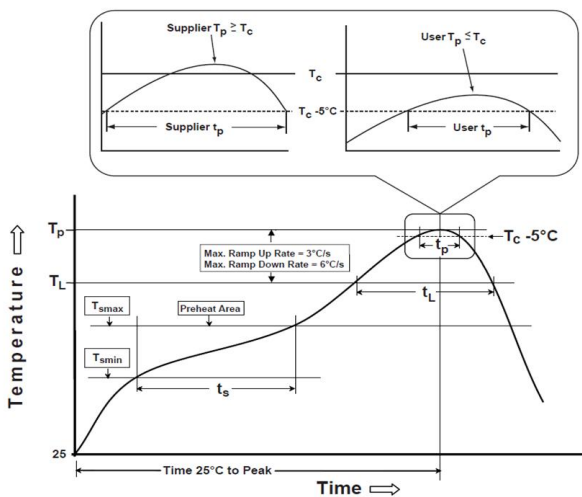

Reflow times: 3 times Max

Figure 1: IR Soldering Reflow

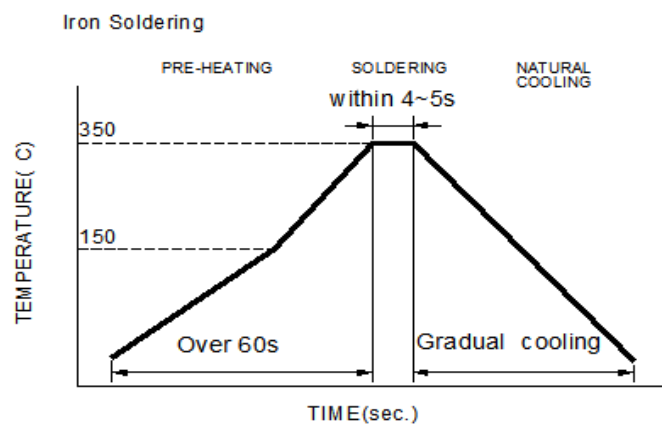

Iron Soldering times: 1 times max.

Soldering iron method: 350±5°C Max

Figure 2: Iron soldering temperature profiles

NOTE: Specifications subject to change without notice. Please check our website for latest information.

Table (1.1) Reflow Profiles

| | |
|--|------------------|
| Profile Type: | Pb-Free Assembly |
| Preheat | |
| -Temperature Min (T_{smin}) | 150°C |
| -Temperature Max (T_{smax}) | 200°C |
| -Time (t_s) from (T_{smin} to T_{smax}) | 60-120seconds |
| Ramp-up rate (T_L to T_p) | 3°C /second max. |
| Liquids temperature (T_L) | 217°C |
| Time (t_L) maintained above T_L | 60-150 seconds |
| Classification temperature (T_c) | See Table (1.2) |
| Time (t_p) at $T_c - 5^\circ\text{C}$ (T_p should be equal to or less than T_c .) | * < 30 seconds |
| Ramp-down rate (T_p to T_L) | 6°C /second max. |
| Time 25°C to peak temperature | 8 minutes max. |

T_p: maximum peak package body temperature, **T_c**: the classification temperature.

For user (customer) **T_p** should be equal to or less than **T_c**.

*Tolerance for peak profile temperature (T_p) is defined as a supplier minimum and a user maximum.

Table (1.2) Package Thickness/Volume and Classification Temperature (T_c)

| | Package Thickness | Volume mm ³ <350 | Volume mm ³ 350-2000 | Volume mm ³ >2000 |
|------------------|-------------------|-----------------------------|---------------------------------|------------------------------|
| PB-Free Assembly | <1.6mm | 260°C | 260°C | 260°C |
| | 1.6-2.5mm | 260°C | 250°C | 245°C |
| | ≥2.5mm | 250°C | 245°C | 245°C |

Reflow is referred to standard IPC/JEDEC J-STD-020E.

NOTE: Specifications subject to change without notice. Please check our website for latest information.

9. Packaging Information

9-1. Reel Dimension (Unit: mm)

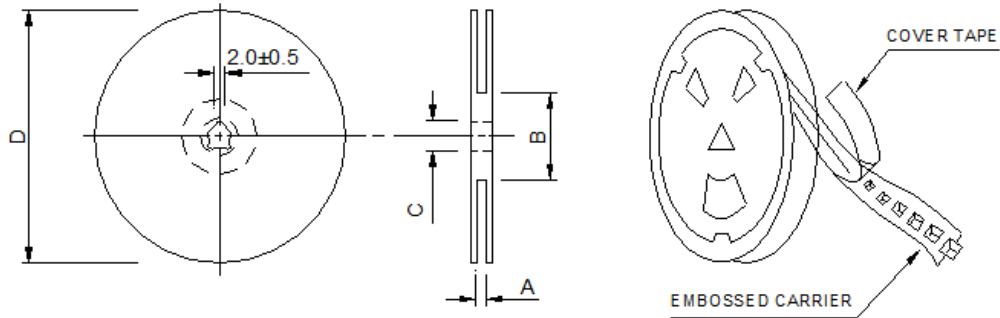

| Type | A | B | C | D |
|----------|---------------|-----------|----------|-------|
| 13"x24mm | 24.4+2.0/-0.0 | 100.0±2.0 | 13.5+0.5 | 330.0 |

9-2. Tape Dimension (Unit: mm)

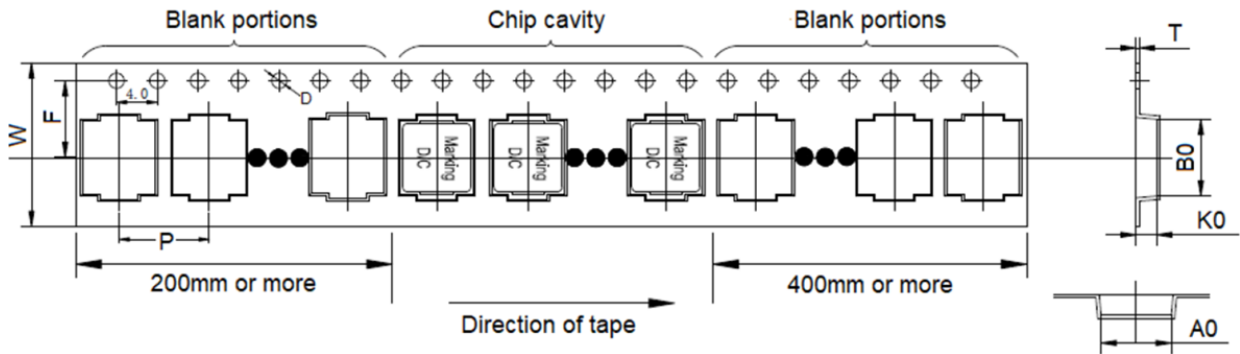

| | | | |
|------------|------------|-----------|------------|
| B0 | A0 | K0 | P |
| 11.60±0.10 | 10.40±0.10 | 4.50±0.10 | 16.00±0.10 |
| W | F | T | D |
| 24.00±0.30 | 11.50±0.10 | 0.35±0.05 | 1.50±0.10 |

NOTE: Specifications subject to change without notice. Please check our website for latest information.

9-3. Packaging Quantity (Unit: Pcs)

| | |
|------------|-------|
| Chip/ Reel | 500 |
| Inner box | 1,000 |
| Carton | 4,000 |

9-4. Tearing Off Force

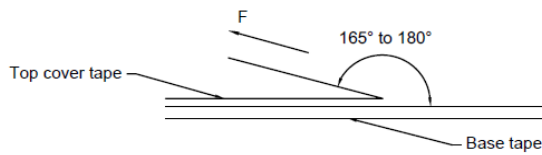

The force for tearing off cover tape is according to the follow table, in the arrow direction under the following conditions.

(Referenced ANSI/EIA-481-D-2008 of 4.11 standard)

| Room Temp. (°C) | Room Humidity (%) | Room atm (hPa) | Tearing Speed (mm/min) |
|-----------------|-------------------|----------------|------------------------|
| 5~35 | 45~85 | 860~1060 | 300±10 |

| Tape Size | 8 mm | 12 to 56 mm | 72 mm or Wider |
|---------------------------|--------|-------------|----------------|
| Tearing Off Force (grams) | 10~100 | 10~130 | 10~150 |

Application Notice

1. Storage Conditions

To maintain the solderability of terminal electrodes:

- (a) Recommended products should be used within 12 months from the time of delivery.
- (b) The packaging material should be kept where no chlorine or sulfur exists in the air.

2. Transportation

- (a) Products should be handled with care to avoid damage or contamination from perspiration and skin oils.
- (b) Vacuum pick up is strongly recommended for individual components.
- (c) Bulk handling should ensure that abrasion and mechanical shock are minimized.

NOTE: Specifications subject to change without notice. Please check our website for latest information.