

1. Part No. Expression

Z Q 3 H 102 - R D - 10

(a) (b) (c) (d) (e) (f) (g)

- (a) Series Code
- (b) Dimension Code
- (c) Material Code
- (d) Impedance Code
- (e) Packaging Code
- (f) Current Code
- (g) Internal Code

2. Configuration & Dimensions (Unit: mm)

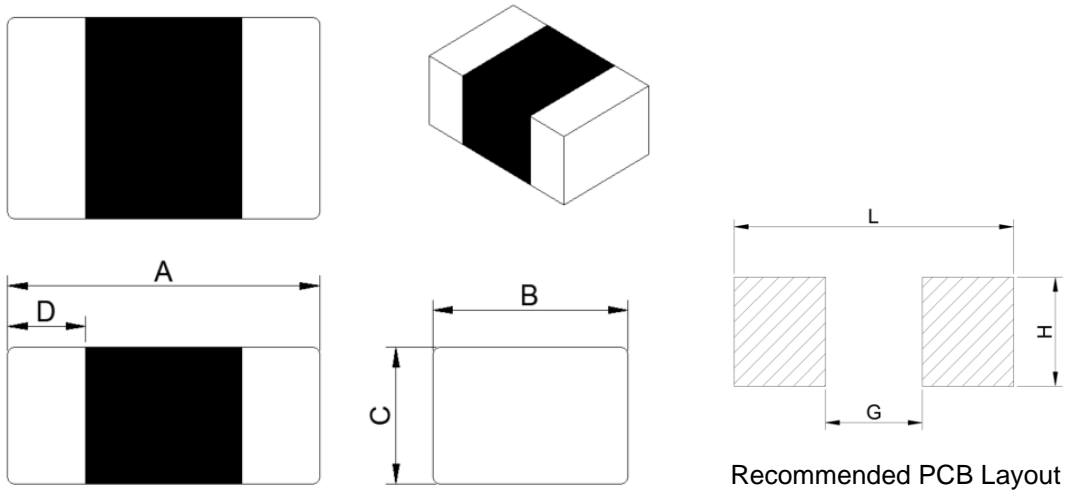

A	B	C	D	L	G	H
2.00±0.20	1.25±0.20	0.85±0.20	0.50±0.30	3.10 Ref	1.00 Ref	1.45 Ref

NOTE: Specifications subject to change without notice. Please check our website for latest information.

3. General Specifications

- (a) Reliability test for this part meets AEC-Q200 standard.
- (b) Operating Temp.: -55°C to +150°C (including self-temperature rise)
- (c) Storage Temp.: -55°C to +150°C (on board)
- (d) Irms: Based on temperature rise ΔT 20°C Max at rated current < 1A and ΔT 40°C Max at rated current $\geq 1A$
- (e) Storage Condition (Component in its packaging)
 - i) Temperature: Less than 40°C
 - ii) Humidity: Less than 60% RH

4. Electrical Characteristics

Part Number	Impedance (Ω) $\pm 25\%$	Test Frequency (MHz)	DCR (Ω) Max	Rated Current (mA) Max
ZQ3H102-RD-10	1000	100	0.45	400
ZQ3H152-RD-10	1500	100	0.50	350
ZQ3H202-RC-10	2000	100	0.60	250

NOTE: Specifications subject to change without notice. Please check our website for latest information.

5. Characteristics Curve

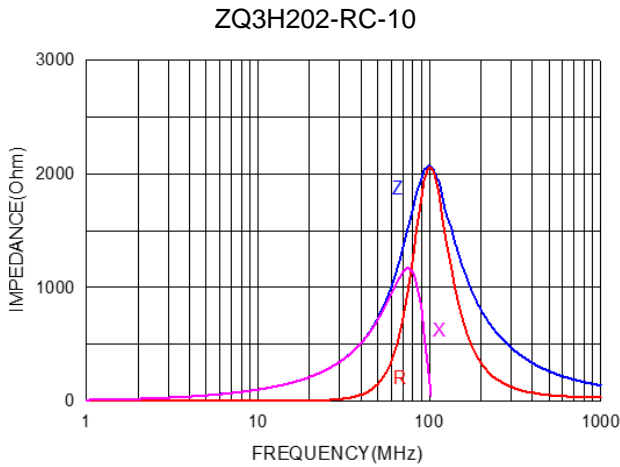
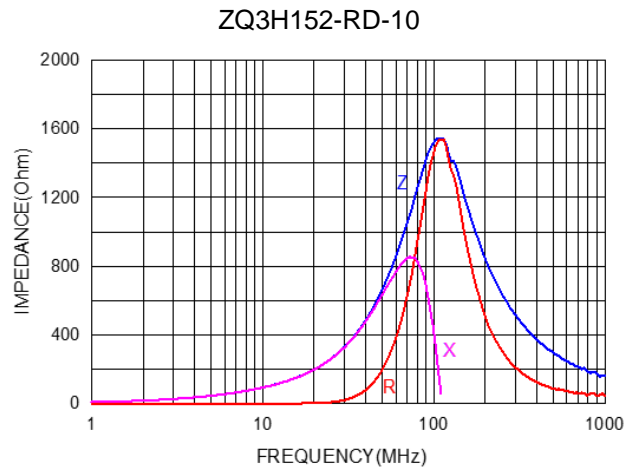
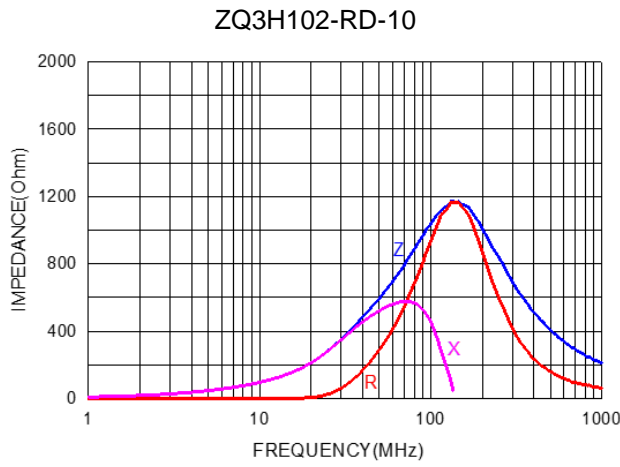

NOTE: Specifications subject to change without notice. Please check our website for latest information.

6. Soldering Specification

Mildly activated rosin fluxes are preferred. Our terminations are suitable for re-flow soldering systems. If hand soldering cannot be avoided, the preferred technique is the utilization of hot air soldering tools.

6-1. IR Soldering Reflow

Recommended temperature profiles for lead free re-flow soldering in Figure 1, Table 1.1 & 1.2 (J-STD-020E).

6-2. Iron Reflow

Products attachment with a soldering iron is discouraged due to the inherent process control limitations. In the event that a soldering iron must be employed the following precautions are recommended (Figure 2).

Note:

- (a) Preheat circuit and products to 150°C.
- (b) 355°C tip temperature (Max.)
- (c) Never contact the ceramic with the iron tip
- (d) 1.0mm tip diameter (Max.)
- (e) Use a 20 watt soldering iron with tip diameter of 1.0mm
- (f) Limit soldering time to 4~5 sec.

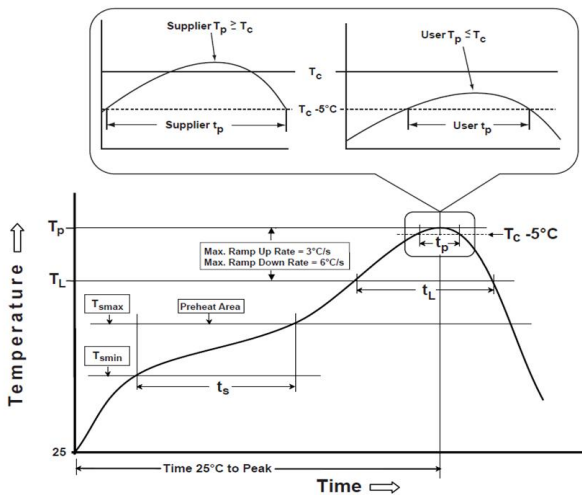

Reflow times: 3 times Max

Figure 1: IR Soldering Reflow

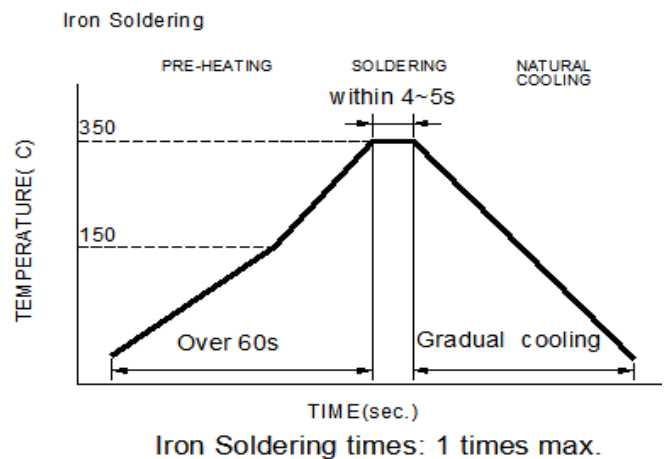

Soldering iron method: 350±5°C Max

Figure 2: Iron soldering temperature profiles

NOTE: Specifications subject to change without notice. Please check our website for latest information.

Table (1.1) Reflow Profiles

Profile Type:	Pb-Free Assembly
Preheat	
-Temperature Min (T_{smin})	150°C
-Temperature Max (T_{smax})	200°C
-Time (t_s) from (T_{smin} to T_{smax})	60-120seconds
Ramp-up rate (T_L to T_p)	3°C /second max.
Liquids temperature (T_L)	217°C
Time (t_L) maintained above T_L	60-150 seconds
Classification temperature (T_c)	See Table (1.2)
Time (t_p) at $T_c - 5^\circ\text{C}$ (T_p should be equal to or less than T_c .)	* < 30 seconds
Ramp-down rate (T_p to T_L)	6°C /second max.
Time 25°C to peak temperature	8 minutes max.

T_p: maximum peak package body temperature, **T_c**: the classification temperature.

For user (customer) **T_p** should be equal to or less than **T_c**.

*Tolerance for peak profile temperature (T_p) is defined as a supplier minimum and a user maximum.

Table (1.2) Package Thickness/Volume and Classification Temperature (T_c)

	Package Thickness	Volume mm ³ <350	Volume mm ³ 350-2000	Volume mm ³ >2000
PB-Free Assembly	<1.6mm	260°C	260°C	260°C
	1.6-2.5mm	260°C	250°C	245°C
	≥2.5mm	250°C	245°C	245°C

Reflow is referred to standard IPC/JEDEC J-STD-020E.

NOTE: Specifications subject to change without notice. Please check our website for latest information.

7. Packaging Information

7-1. Reel Dimension (Unit: mm)

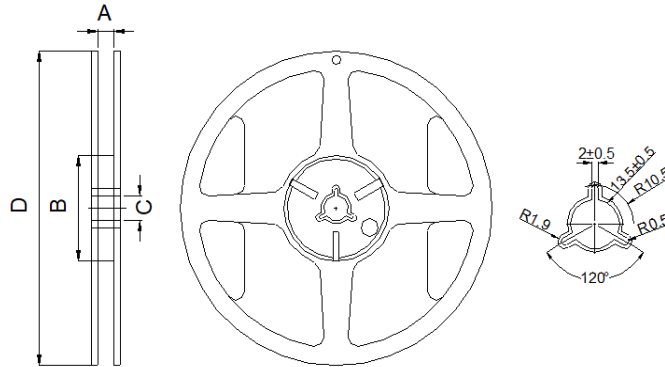

Type	A	B	C	D
7"x8mm	9.0±0.5	60.0±2.0	13.5±0.5	178.0±2.0

7-2. Tape Dimension (Unit: mm)

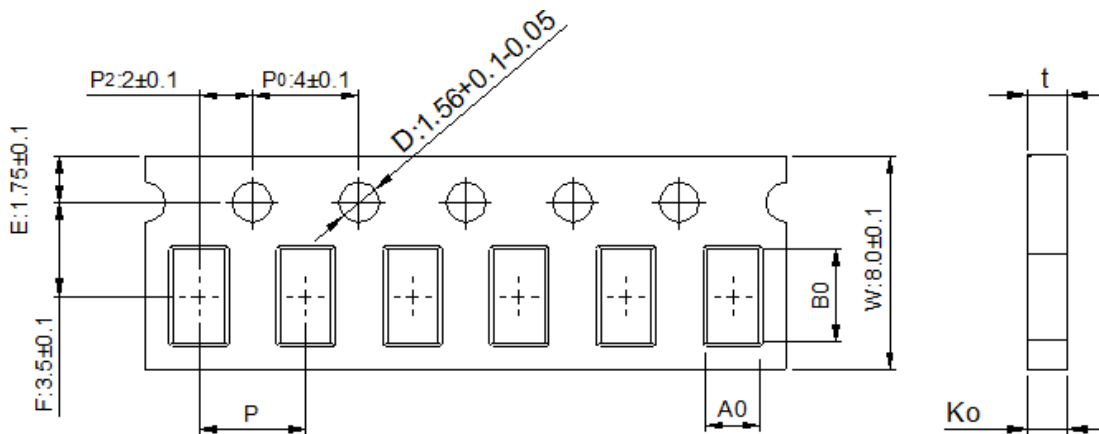

B0	A0	Ko	P	t
2.10±0.05	1.30±0.05	0.95±0.05	4.00±0.10	0.95±0.05

NOTE: Specifications subject to change without notice. Please check our website for latest information.

7-3. Packaging Quantity (Unit: Pcs)

Chip/ Reel	4,000
Inner Box	20,000
Middle Box	100,000
Carton	200,000

7-4. Tearing Off Force

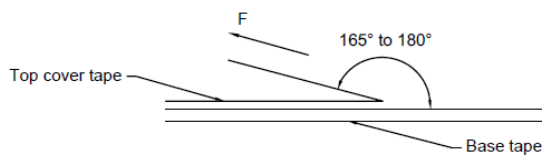

The force for tearing off cover tape is according to the follow table, in the arrow direction under the following conditions.

(Referenced ANSI/EIA-481-D-2008 of 4.11 standard)

Room Temp. (°C)	Room Humidity (%)	Room atm (hPa)	Tearing Speed (mm/min)
5~35	45~85	860~1060	300±10

Tape Size	8 mm	12 to 56 mm	72 mm or Wider
Tearing Off Force (grams)	10~100	10~130	10~150

Application Notice

1. Storage Conditions

To maintain the solderability of terminal electrodes:

- (a) Recommended products should be used within 12 months from the time of delivery.
- (b) The packaging material should be kept where no chlorine or sulfur exists in the air.

2. Transportation

- (a) Products should be handled with care to avoid damage or contamination from perspiration and skin oils.
- (b) Vacuum pick up is strongly recommended for individual components.
- (c) Bulk handling should ensure that abrasion and mechanical shock are minimized.

NOTE: Specifications subject to change without notice. Please check our website for latest information.