

1. Part No. Expression

PIF1513A4R7M0

(a) (b) (c) (d) (e) (f)

- | | |
|--------------------|---------------------|
| (a) Series Code | (d) Inductance Code |
| (b) Dimension Code | (e) Tolerance Code |
| (c) Material Code | (f) Special Code |

2. Configuration & Dimensions (Unit: mm)

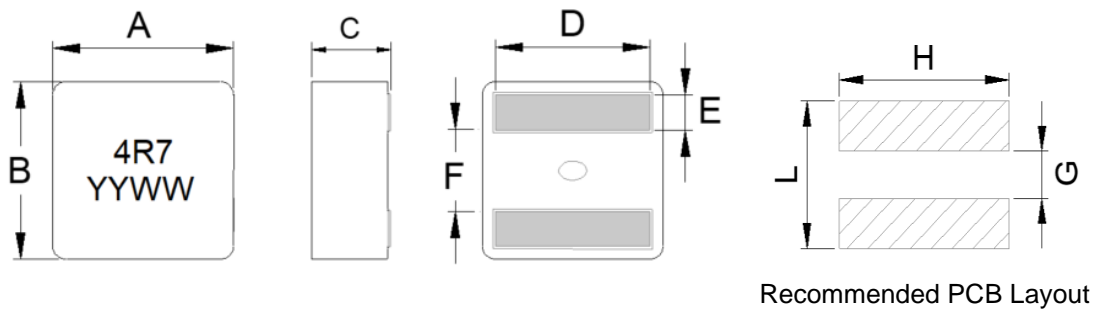

- Note:
1. The above PCB layout reference only.
 2. Recommend solder paste thickness at 0.15 mm and above.
 3. Marking: Top= Inductance Code, Bottom=YYWW (Year/World week)

A	B	C	D	E
17.5±0.3	16.5±0.3	12.7±0.3	13.2±0.5	3.2±0.2
F	L	G	H	-
7.0±0.3	15.0 Ref	6.0 Ref	15.0 Ref	-

NOTE: Specifications subject to change without notice. Please check our website for latest information.

3. Material List

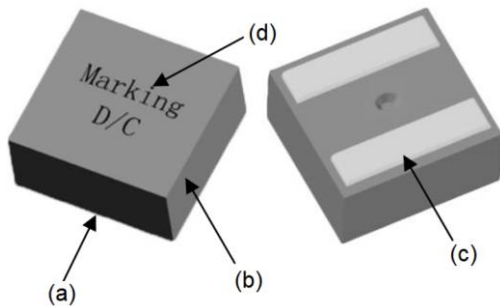

- (a) Core
- (b) Wire
- (c) Solder
- (d) Ink

4. General Specifications

- (a) Operating Temp.: -40°C to +125°C (including self-temperature rise)
- (b) Storage Temp.: -40°C to +125°C (on board)
- (c) All test data referenced to 25°C ambient.
- (d) Heat Rated Current (I_{rms}) will cause the coil temperature rise approximately ΔT 20°C & of 40°C.
- (e) Saturation Current (I_{sat}) will cause inductance L₀ to drop approximately 30%.
- (f) Rated Current: The lower value of I_{sat} and I_{rms}.
- (g) Part Temperature (Ambient + Temp. Rise): Should not exceed 125°C under worst case operating conditions.
- (h) Maximum operating voltage: 40V
- (i) Storage Condition (Component in its packaging)
 - i) Temperature: Less than 40°C
 - ii) Humidity: Less than 60% RH

NOTE: Specifications subject to change without notice. Please check our website for latest information.

5. Electrical Characteristics

Part Number	Inductance (uH) @0A ±20%	Irms(A)		Isat(A)		DCR(mΩ)	
		@20°C rise	@40°C rise	Typ	Max	Typ	Max
PIF1513A4R7MO	4.70	23.0	31.0	44.0	40.0	3.0	3.3
PIF1513A5R6MO	5.60	22.0	29.0	40.0	35.0	3.5	3.9
PIF1513A6R8MO	6.80	21.0	27.0	37.0	32.0	3.8	4.2
PIF1513A8R2MO	8.20	20.0	26.0	33.0	29.0	5.1	5.74
PIF1513A100MO	10.0	19.0	25.0	30.0	27.0	6.3	7.0
PIF1513A150MO	15.0	16.0	22.0	25.5	21.0	6.8	7.5
PIF1513A220MO	22.0	12.0	17.0	22.0	19.0	12.6	13.86
PIF1513A330MO	33.0	9.0	14.0	19.0	16.0	18.5	22.2

Test frequency: 0.1V/100kHz

6. Characteristics Curve

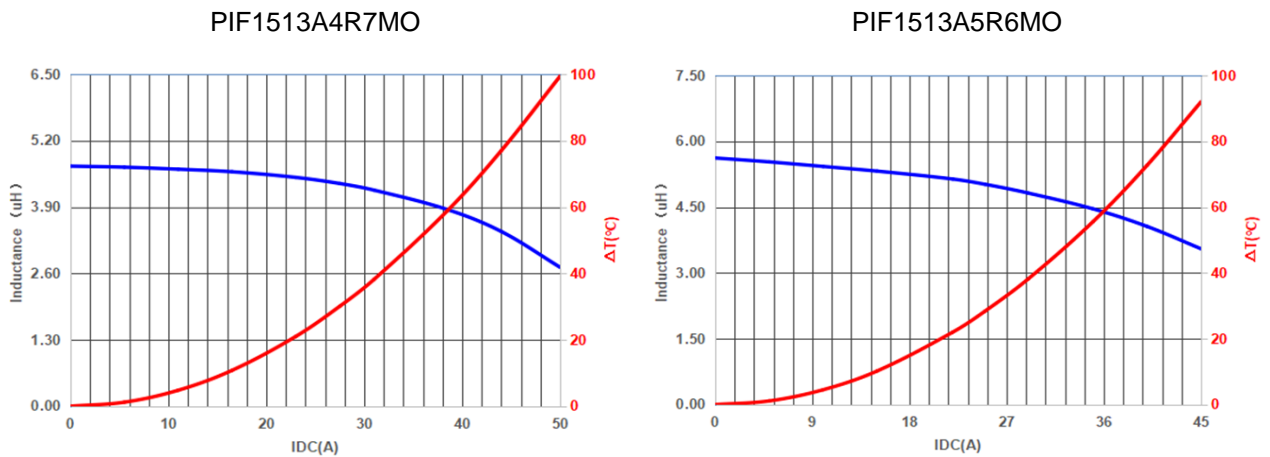

NOTE: Specifications subject to change without notice. Please check our website for latest information.

PIF1513A6R8MO

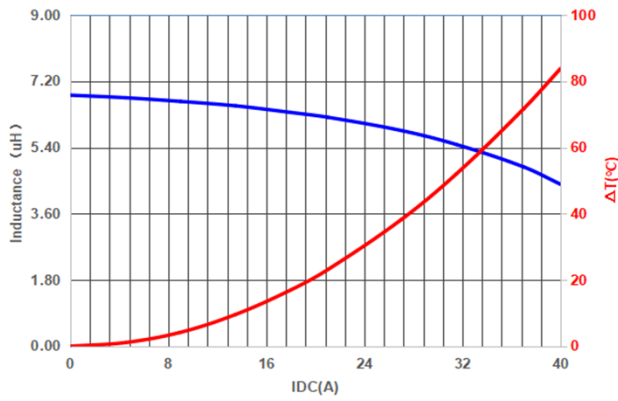

PIF1513A8R2MO

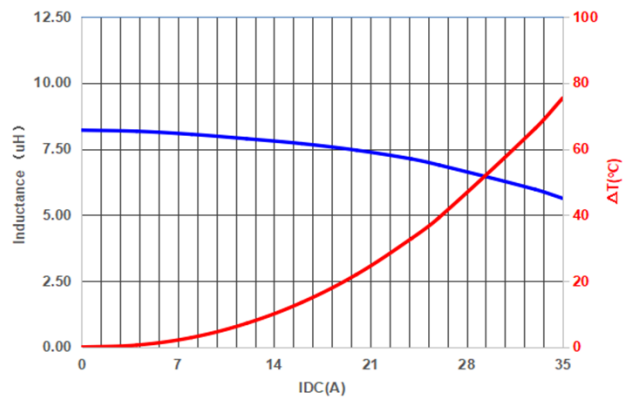

PIF1513A100MO

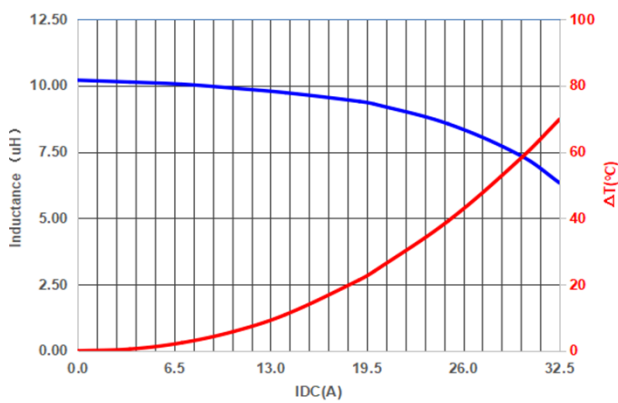

PIF1513A150MO

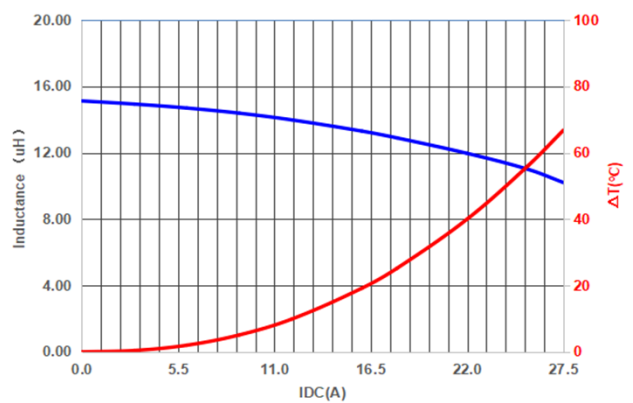

PIF1513A220MO

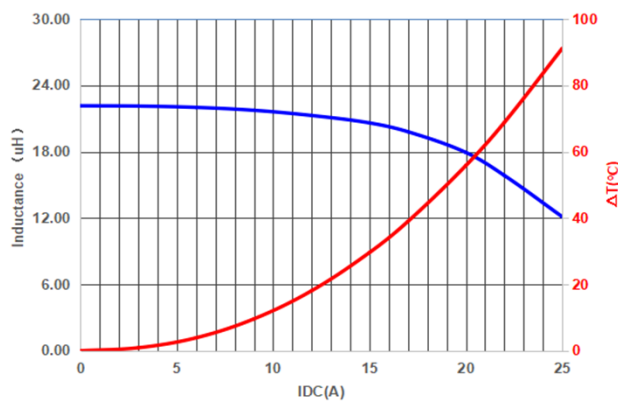

PIF1513A330MO

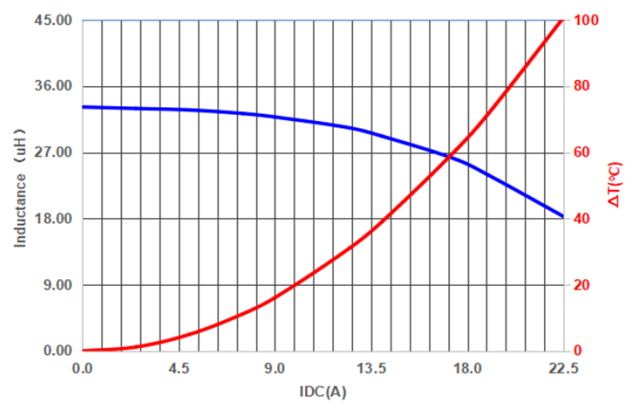

NOTE: Specifications subject to change without notice. Please check our website for latest information.

7. Soldering Specification

Mildly activated rosin fluxes are preferred. Our terminations are suitable for re-flow soldering systems. If hand soldering cannot be avoided, the preferred technique is the utilization of hot air soldering tools.

7-1. IR Soldering Reflow

Recommended temperature profiles for lead free re-flow soldering in Figure 1, Table 1.1 & 1.2 (J-STD-020E).

7-2. Iron Reflow

Products attachment with a soldering iron is discouraged due to the inherent process control limitations. In the event that a soldering iron must be employed the following precautions are recommended (Figure 2).

Note:

- (a) Preheat circuit and products to 150°C.
- (b) 355°C tip temperature (Max.)
- (c) Never contact the ceramic with the iron tip
- (d) 1.0mm tip diameter (Max.)
- (e) Use a 20 watt soldering iron with tip diameter of 1.0mm
- (f) Limit soldering time to 4~5 sec.

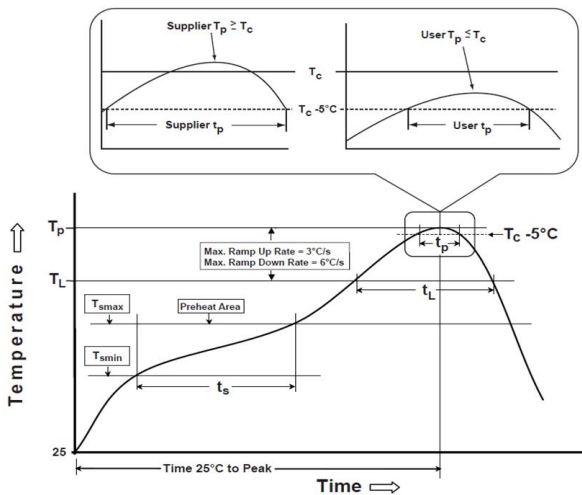

Reflow times: 3 times Max

Figure 1: IR Soldering Reflow

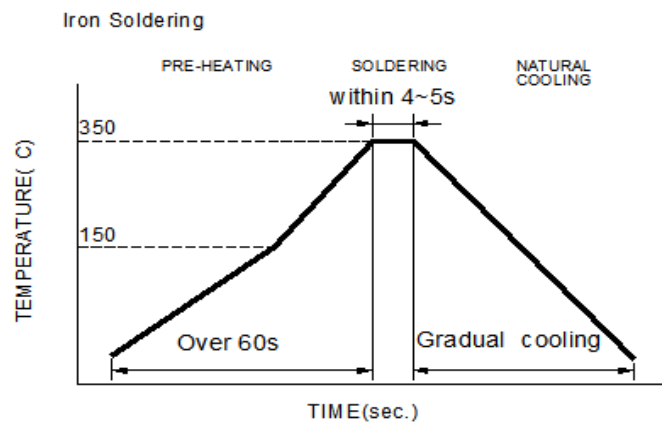

Iron Soldering times: 1 times max.

Soldering iron method: 350±5°C Max

Figure 2: Iron soldering temperature profiles

NOTE: Specifications subject to change without notice. Please check our website for latest information.

Table (1.1) Reflow Profiles

Profile Type:	Pb-Free Assembly
Preheat	
-Temperature Min (T_{smin})	150°C
-Temperature Max (T_{smax})	200°C
-Time (t_s) from (T_{smin} to T_{smax})	60-120seconds
Ramp-up rate (T_L to T_p)	3°C /second max.
Liquids temperature (T_L)	217°C
Time (t_L) maintained above T_L	60-150 seconds
Classification temperature (T_c)	See Table (1.2)
Time (t_p) at $T_c - 5^\circ\text{C}$ (T_p should be equal to or less than T_c .)	* < 30 seconds
Ramp-down rate (T_p to T_L)	6°C /second max.
Time 25°C to peak temperature	8 minutes max.

T_p: maximum peak package body temperature, **T_c**: the classification temperature.

For user (customer) **T_p** should be equal to or less than **T_c**.

*Tolerance for peak profile temperature (T_p) is defined as a supplier minimum and a user maximum.

Table (1.2) Package Thickness/Volume and Classification Temperature (T_c)

	Package Thickness	Volume mm ³ <350	Volume mm ³ 350-2000	Volume mm ³ >2000
PB-Free Assembly	<1.6mm	260°C	260°C	260°C
	1.6-2.5mm	260°C	250°C	245°C
	≥2.5mm	250°C	245°C	245°C

Reflow is referred to standard IPC/JEDEC J-STD-020E.

NOTE: Specifications subject to change without notice. Please check our website for latest information.

8. Packaging Information

8-1. Reel Dimension (Unit: mm)

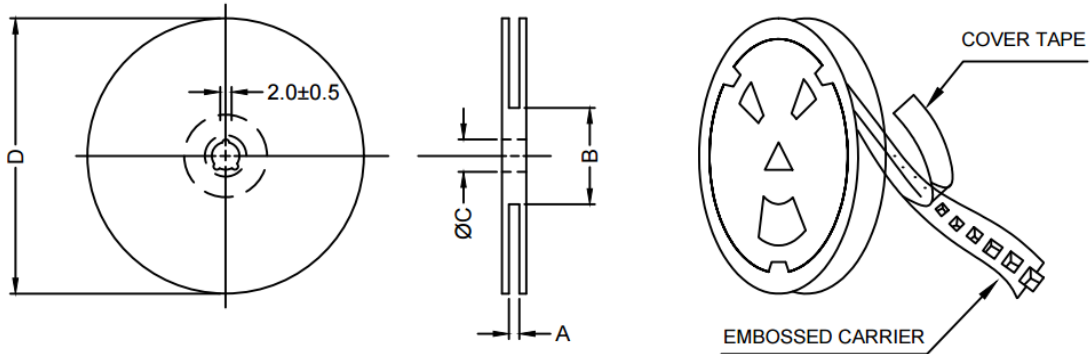

Type	A	B	C	D
13" x 32mm	32.4 + 2.0 / - 0.0	100.0 ± 2.0	13.0 + 0.5 / - 0.2	330.0

8-2. Tape Dimension (Unit: mm)

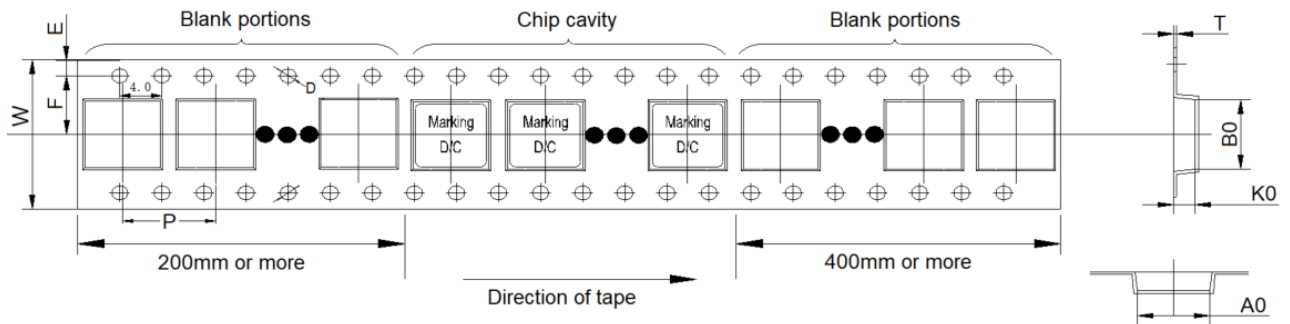

B0	A0	K0	P	W
17.00 ± 0.10	18.00 ± 0.10	13.60 ± 0.10	24.00 ± 0.10	32.00 ± 0.30
E	F	T	D	-
1.75 ± 0.10	14.20 ± 0.10	0.50 ± 0.05	1.50 ± 0.10	-

NOTE: Specifications subject to change without notice. Please check our website for latest information.

8-3. Packaging Quantity (Unit: Pcs)

Chip/ Reel	100
------------	-----

8-4. Tearing Off Force

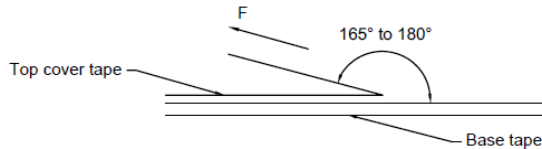

The force for tearing off cover tape is according to the follow table, in the arrow direction under the following conditions.

(Referenced ANSI/EIA-481-D-2008 of 4.11 standard)

Room Temp. (°C)	Room Humidity (%)	Room atm (hPa)	Tearing Speed (mm/min)
5~35	45~85	860~1060	300±10

Tape Size	8 mm	12 to 56 mm	72 mm or Wider
Tearing Off Force (grams)	10~100	10~130	10~150

Application Notice

1. Storage Conditions

To maintain the solderability of terminal electrodes:

- (a) Recommended products should be used within 12 months from the time of delivery.
- (b) The packaging material should be kept where no chlorine or sulfur exists in the air.

2. Transportation

- (a) Products should be handled with care to avoid damage or contamination from perspiration and skin oils.
- (b) Vacuum pick up is strongly recommended for individual components.
- (c) Bulk handling should ensure that abrasion and mechanical shock are minimized.

NOTE: Specifications subject to change without notice. Please check our website for latest information.