

1. Part No. Expression:

Z 3 K 3 0 0 - R F - □□

(a)(b) (c) (d) (e) (f) (g)

(a) Series Code

(b) Dimension Code

(c) Material Code

(d) Impedance Code

(e) R: Reel

(f) Current Code: F=600mA

(g) 10: Standard

11-99: Internal Controlled Code

2. Configuration & Dimensions:

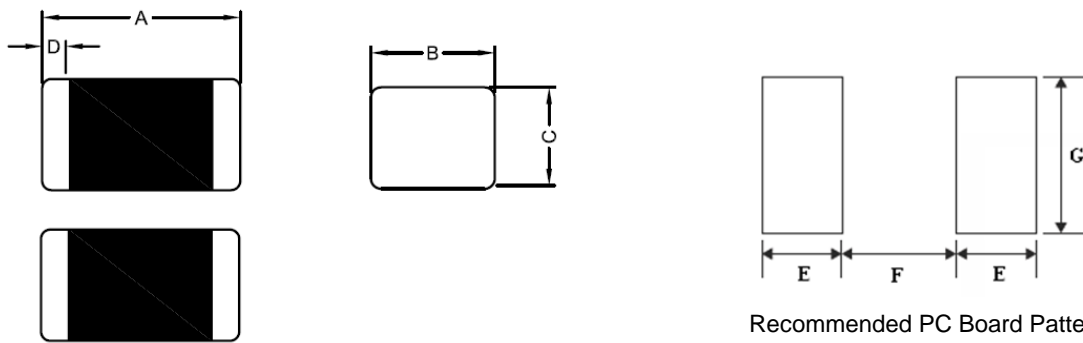

Unit : mm

| A | B | C | D | E | F | G |
|-------------|-------------|-------------|-------------|-----------|-----------|-----------|
| 2.00 ± 0.20 | 1.25 ± 0.20 | 0.85 ± 0.20 | 0.50 ± 0.30 | 1.05 Ref. | 1.00 Ref. | 1.45 Ref. |

3. Schematic:

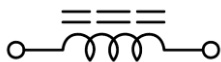

4. Material List:

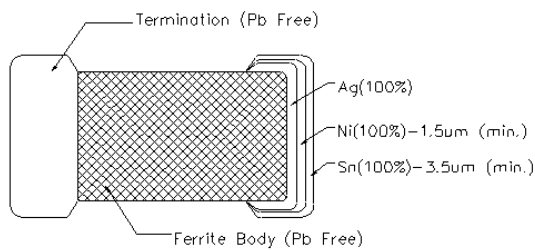

NOTE: Specifications subject to change without notice. Please check our website for latest information.



5. General Specification:

- (a) Operating Temp. : -55°C to +125°C
- (b) Storage Temp. : -55°C to +125°C
- (c) Temperature Rise: 20°C Max. at Rated Current <1A
- (d) Storage Condition (Component in its packaging)
 - i) Temperature: 40°C or less
 - ii) Humidity : 60% RH or less

6. Electrical Characteristics:

| Part Number | Impedance (Ω) | Test Frequency (MHz) | DCR (Ω) Max. | Rated Current (mA) Max. |
|--------------|---------------|----------------------|--------------|-------------------------|
| Z3K110-RI-10 | 11 ± 25% | 100 | 0.10 | 900 |
| Z3K170-RF-10 | 17 ± 25% | 100 | 0.10 | 600 |
| Z3K260-RF-10 | 26 ± 25% | 100 | 0.10 | 600 |
| Z3K300-RF-10 | 30 ± 25% | 100 | 0.10 | 600 |
| Z3K400-RF-10 | 40 ± 25% | 100 | 0.10 | 600 |
| Z3K600-RI-10 | 60 ± 25% | 100 | 0.10 | 900 |
| Z3K121-RH-10 | 120 ± 25% | 100 | 0.20 | 800 |
| Z3K151-RH-10 | 150 ± 25% | 100 | 0.20 | 800 |
| Z3K221-RH-10 | 220 ± 25% | 100 | 0.30 | 750 |
| Z3K301-RG-10 | 300 ± 25% | 100 | 0.30 | 700 |
| Z3K471-RG-10 | 470 ± 25% | 100 | 0.35 | 700 |
| Z3K601-RE-10 | 600 ± 25% | 100 | 0.40 | 500 |
| Z3K102-RD-10 | 1000 ± 25% | 100 | 0.45 | 400 |
| Z3H102-RD-10 | 1000 ± 25% | 100 | 0.45 | 400 |
| Z3H152-RD-10 | 1500 ± 25% | 100 | 0.50 | 350 |
| Z3H202-RC-10 | 2000 ± 25% | 100 | 0.60 | 250 |
| Z3N070-RF-10 | 7 ± 25% | 100 | 0.10 | 600 |
| Z3C121-RF-10 | 120 ± 25% | 100 | 0.25 | 600 |
| Z3C221-RD-10 | 220 ± 25% | 100 | 0.30 | 400 |
| Z3C301-RD-10 | 300 ± 25% | 100 | 0.35 | 400 |

NOTE: Specifications subject to change without notice. Please check our website for latest information.



7.Characteristics Curve:

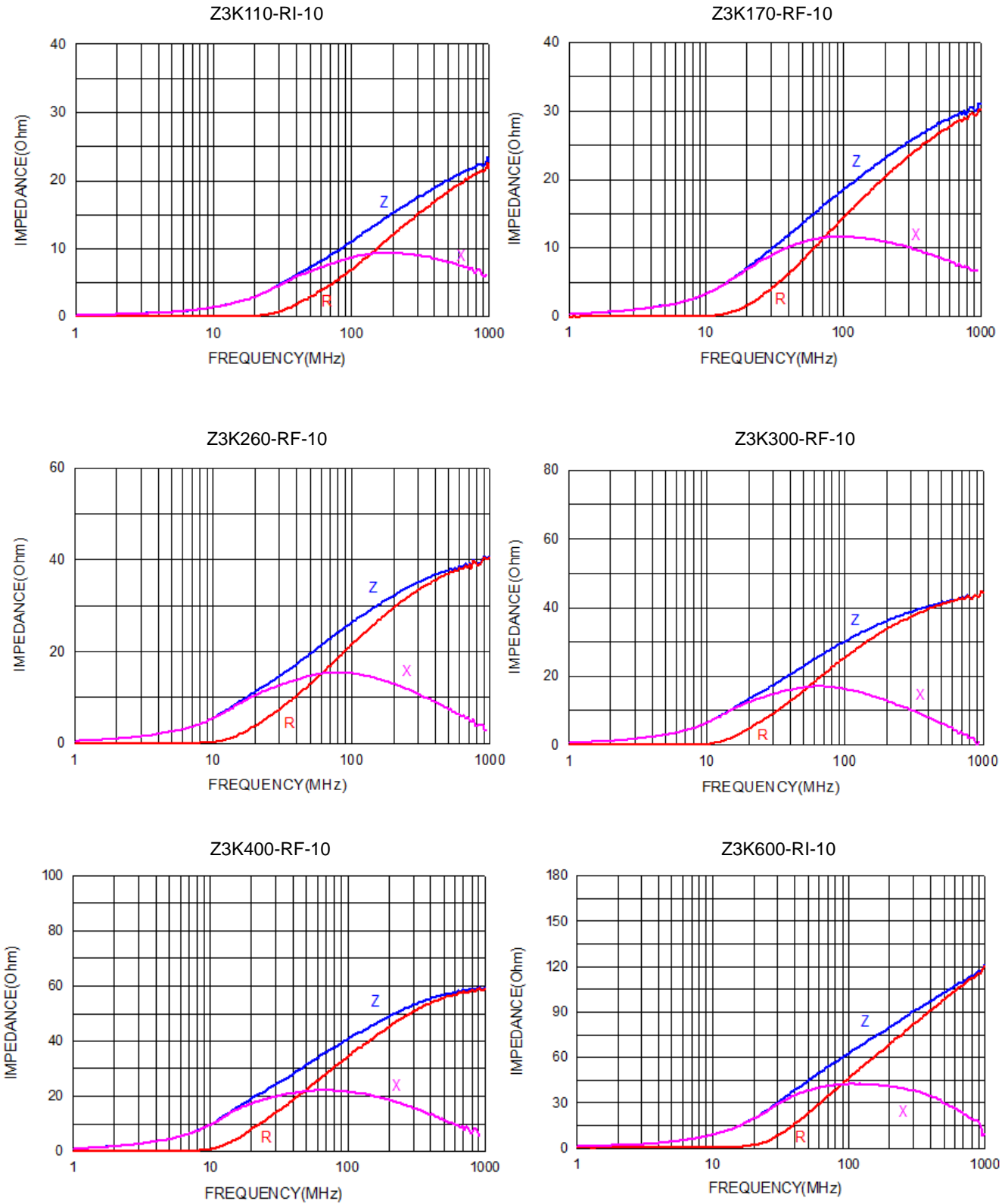

NOTE: Specifications subject to change without notice. Please check our website for latest information.



Z3K121-RH-10

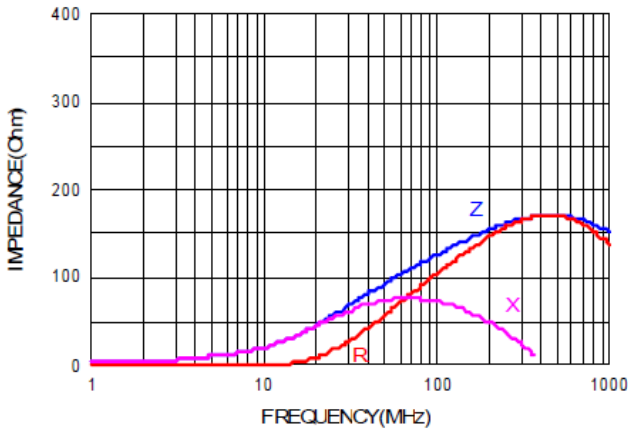

Z3K151-RH-10

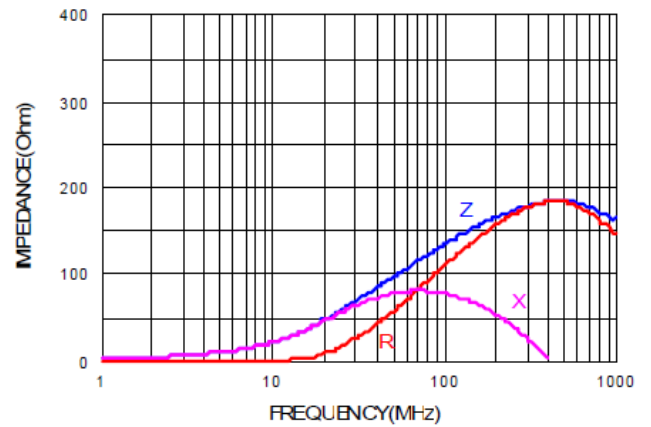

Z3K221-RH-10

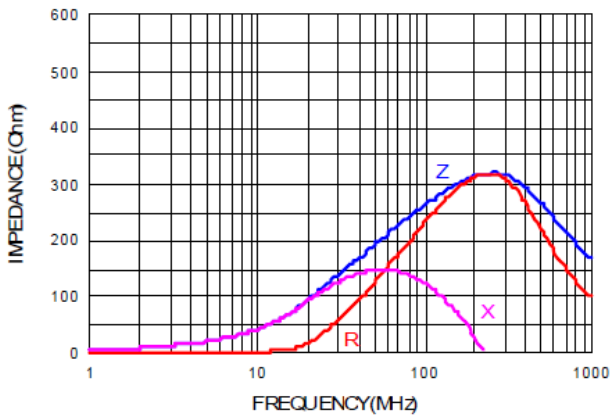

Z3K301-RG-10

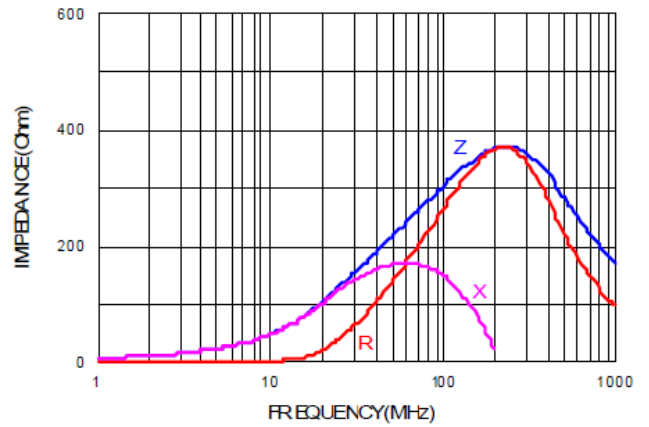

Z3K471-RG-10

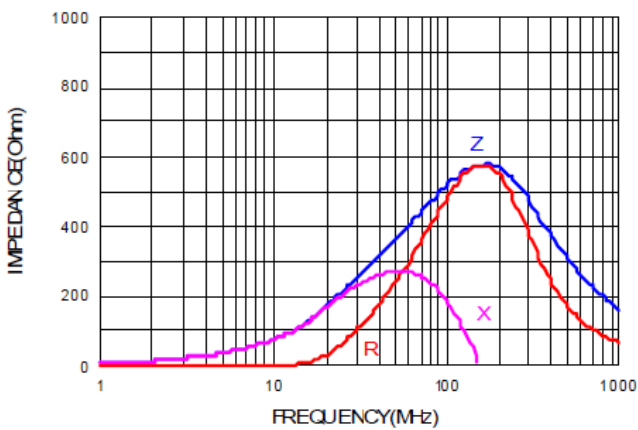

Z3K601-RE-10

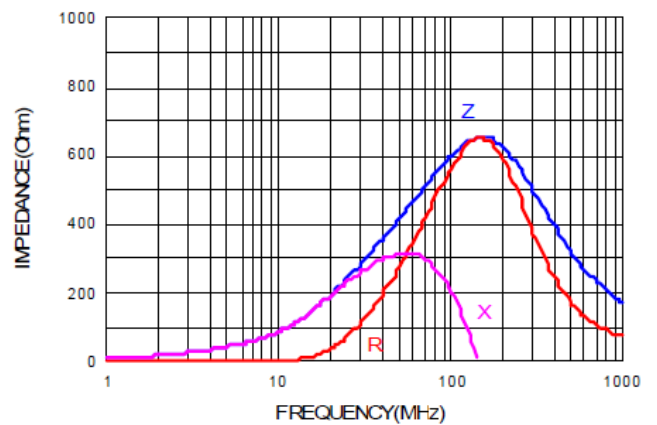

NOTE: Specifications subject to change without notice. Please check our website for latest information.



Z3K102-RD-10

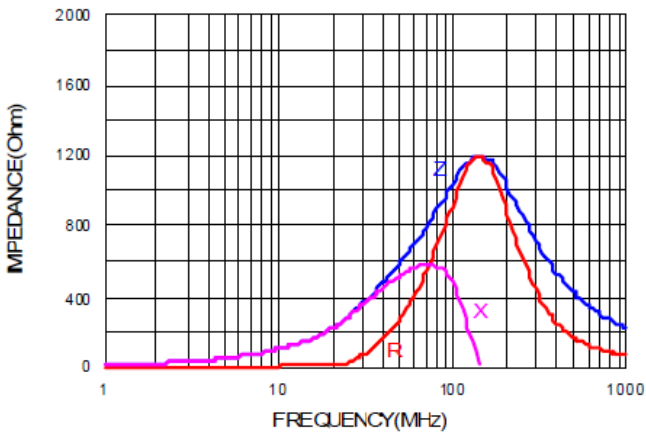

Z3H102-RD-10

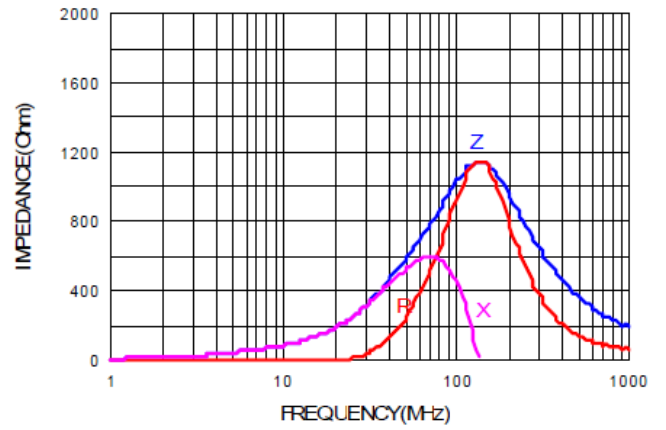

Z3H152-RD-10

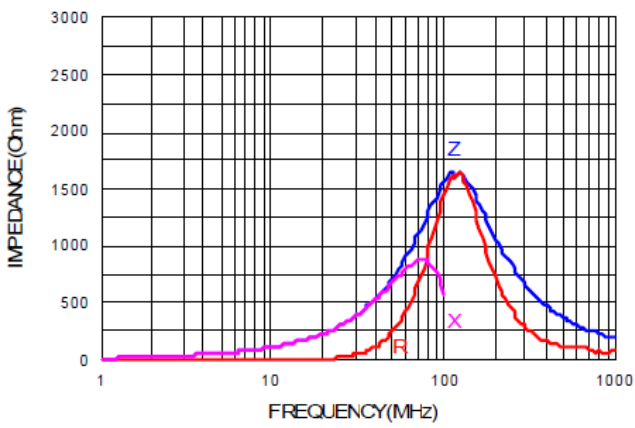

Z3H202-RC-10

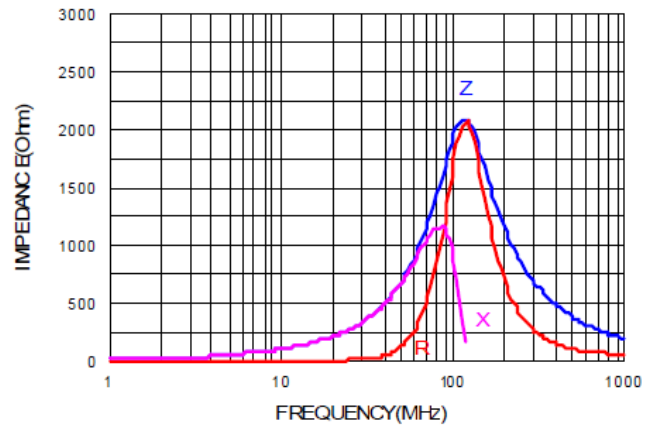

Z3N070-RF-10

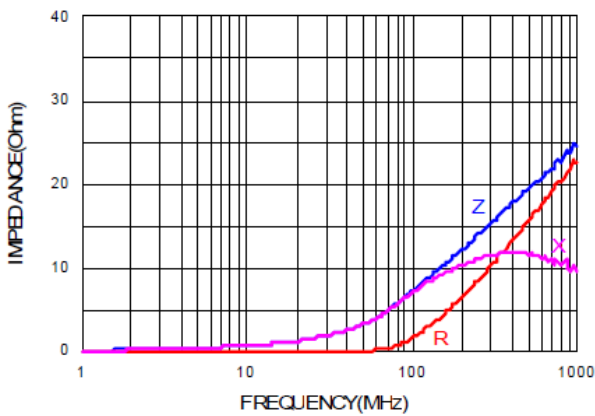

Z3C121-RF-10

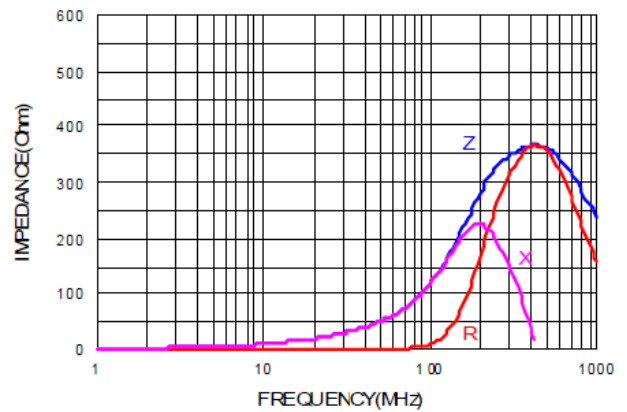

NOTE: Specifications subject to change without notice. Please check our website for latest information.



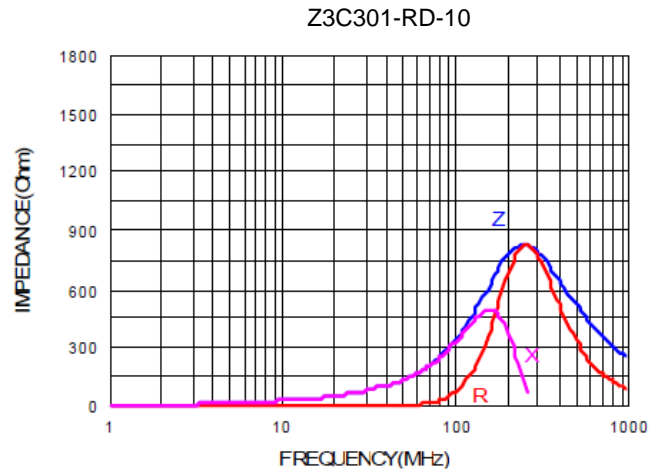
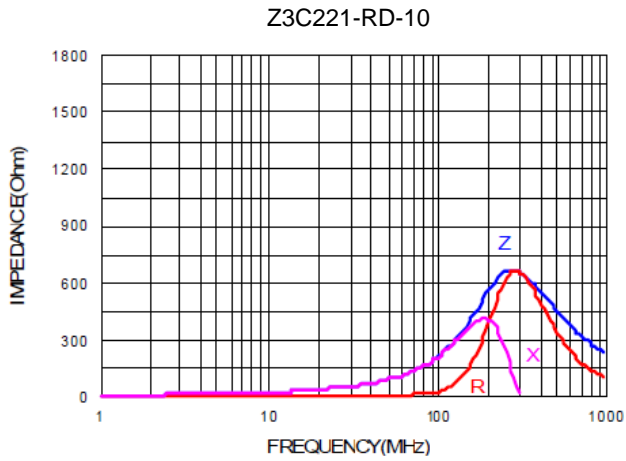

7. Soldering:

Mildly activated rosin fluxes are preferred. Our terminations are suitable for all re-flow soldering systems. If hand soldering cannot be avoided, the preferred technique is the utilization of hot air soldering tools.

Note:

If wave soldering is used, there will be some risk

Reflow soldering temperatures below 240°C, there will be non-wetting risk

8-1 Solder Re-flow:

Recommended temperature profiles for re-flow soldering in Figure 1.

8-2 Soldering Iron (Figure 2):

Products attachment with soldering iron is discouraged due to the inherent process control limitations.

In the event that a soldering iron must be employed the following precautions are recommended.

Note :

- a) Preheat circuit and products to 150°C.
- b) 350°C tip temperature (Max.)
- c) Never contact the ceramic with the iron tip
- d) 1.0mm tip diameter (Max.)
- e) Use a 20 watt soldering iron with tip diameter of 1.0mm
- f) Limit soldering time to 4~5 secs.

NOTE: Specifications subject to change without notice. Please check our website for latest information.



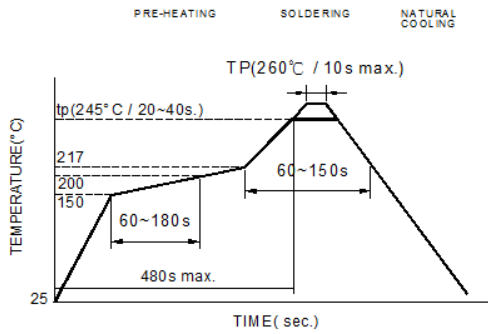

Reflow times: 3 times max
Figure.1

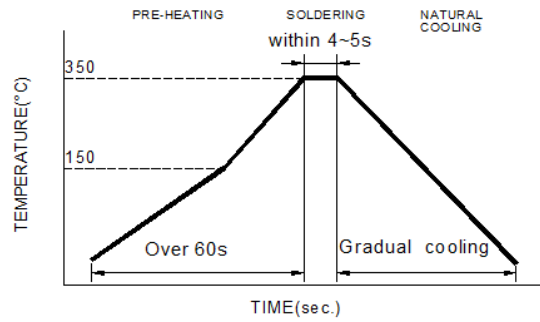

Iron Soldering times : 1 times max
Figure.2

8-3 Soldering Volume:

By increasing the solder volume, the mechanical stress to product is also increased. Exceeding solder volume may cause the failure of mechanical or electrical performance. Solder shall be used not to be exceeded as shown in Figure 3. Minimum fillet height = soldering thickness +25% product height

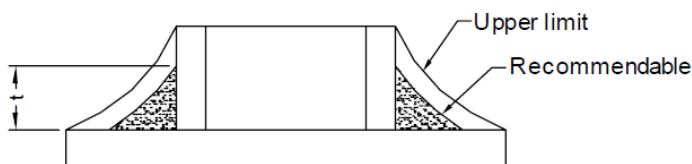
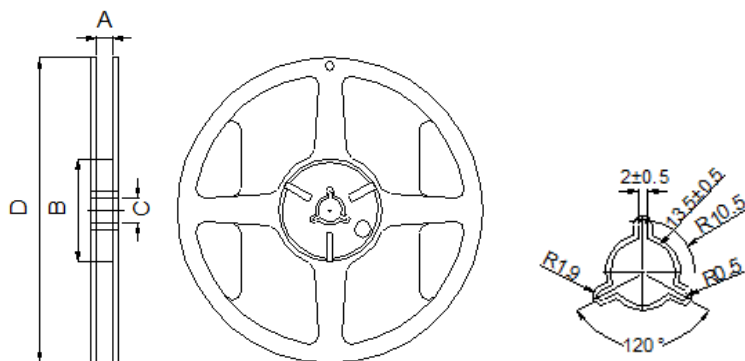

Figure 3

8. Packaging Information:

9-1 Reel Dimension



7"x8mm

| A(mm) | B(mm) | C(mm) | D(mm) |
|---------|----------|----------|-----------|
| 9.0±0.5 | 60.0±2.0 | 13.5±0.5 | 178.0±2.0 |

NOTE: Specifications subject to change without notice. Please check our website for latest information.

9-2 Tape Dimension

Material of taping is paper

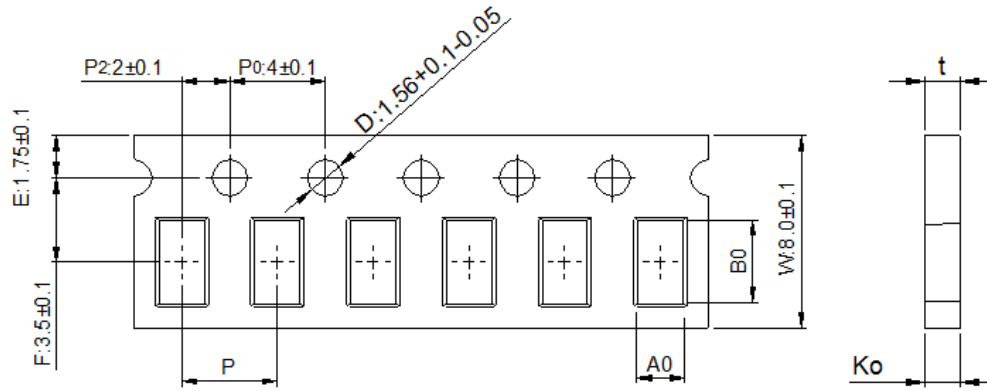

| Size | Bo(mm) | Ao(mm) | Ko(mm) | P(mm) | t(mm) |
|------|-----------|-----------|-----------|-----------|-----------|
| Z3 | 2.10±0.05 | 1.30±0.05 | 0.95±0.05 | 4.00±0.10 | 0.95±0.05 |

9-3 Packaging Quantity

| | |
|-----------|------|
| Chip Size | Z3 |
| Chip/Reel | 4000 |

9-4 Tearing Off Force

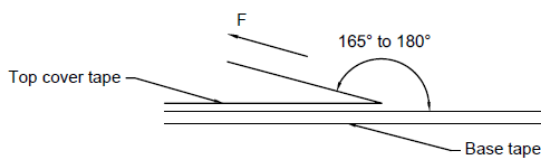

The force for tearing off cover tape is 15 to 60 grams in the arrow direction under the following conditions.

| Room Temp. (°C) | Room Humidity (%) | Room atm (hPa) | Tearing Speed mm/min |
|-----------------|-------------------|----------------|----------------------|
| 5~35 | 45~85 | 860~1060 | 300 |

NOTE: Specifications subject to change without notice. Please check our website for latest information.



Application Notice:

1. Storage Conditions:

To maintain the solderability of terminal electrodes:

- a) Recommended products should be used within 12 months from the time of delivery.
- b) The packaging material should be kept where no chlorine or sulfur exists in the air.

2. Transportation:

- a) Products should be handled with care to avoid damage or contamination from perspiration and skin oils.
- b) Vacuum pick up is strongly recommended for individual components.
- c) Bulk handling should ensure that abrasion and mechanical shock are minimized

NOTE: Specifications subject to change without notice. Please check our website for latest information.

