

1. PART NO. EXPRESSION :

STB 1106 R54 MZF
 (a) (b) (c) (d)(e)(f)

(a) Series code

(b) Dimension code

(c) Inductance code : R54 = 0.54uH

(d) Tolerance code : M = ±20%

(e) Z : Standard part

(f) F : RoHS Compliant

2. CONFIGURATION & DIMENSIONS :

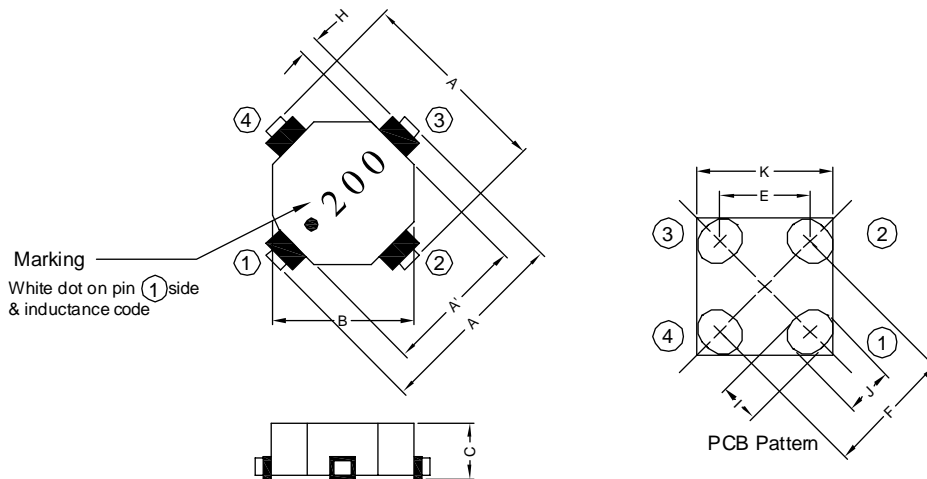

Unit: m/m

A	A'	B	C	E	F	H	I	J	K
11.43 Typ.	8.89 Typ.	8.89 Typ.	5.97 Max.	7.04 Typ.	9.96 Typ.	0.76 Min.	3.05 Typ.	3.69 Typ.	10.70 Typ.

3. SCHEMATIC :

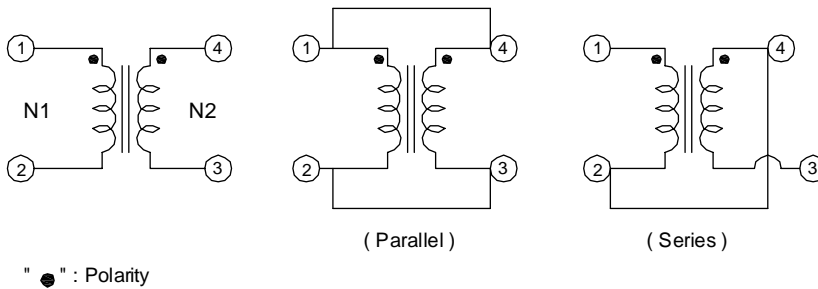

RoHS Compliant

NOTE : Specifications subject to change without notice. Please check our website for latest information.

29.12.2014



SUPERWORLD ELECTRONICS (S) PTE LTD

4. MATERIALS :

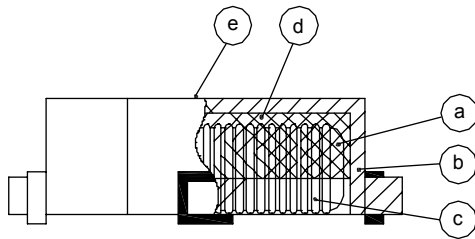

- (a) Core
- (b) Base
- (c) Wire
- (d) Adhesive
- (e) Ink

5. GENERAL SPECIFICATION :

- a) Operating temp. : -40° C to +85° C
- b) Storage condition (component in its packaging)
 - i) Temperature : -10 to 40° C
 - ii) Humidity : 60%
- c) Resistance to solder heat : 260° C.10 secs
- d) Hi-Pot test (N-N) : 500VAC 60Hz 1mA 1sec

6. ELECTRICAL CHARACTERISTICS :

Part No.	Parallel					Series				
	L (μ H) $\pm 20\%$	L IDC (μ H) Min.	Test Frequency (Hz)	RDC (Ω) Max.	IDC (A)	L (μ H) $\pm 20\%$	L IDC (μ H) Min.	Test Frequency (Hz)	RDC (Ω) Max.	IDC (A)
STB1106R54MZF	0.54	0.42	0.25V/100K	0.0060	5.90	2.18	1.69	0.25V/100K	0.024	2.95
STB1106R85MZF	0.85	0.64	0.25V/100K	0.0070	5.40	3.40	2.55	0.25V/100K	0.029	2.70
STB11061R2MZF	1.22	0.89	0.25V/100K	0.0080	5.00	4.90	3.57	0.25V/100K	0.033	2.50
STB11062R2MZF	2.18	1.56	0.25V/100K	0.0140	3.90	8.70	6.26	0.25V/100K	0.055	1.95
STB11064R9MZF	4.90	3.57	0.25V/100K	0.0320	2.50	19.58	14.26	0.25V/100K	0.128	1.25
STB11067R6MZF	7.65	5.31	0.25V/100K	0.0400	2.30	30.60	21.23	0.25V/100K	0.158	1.15
STB1106100MZF	9.83	6.73	0.25V/100K	0.0450	2.10	39.30	26.92	0.25V/100K	0.179	1.05
STB1106150MZF	14.99	10.51	0.25V/100K	0.0850	1.60	59.98	42.02	0.25V/100K	0.339	0.80
STB1106200MZF	19.58	13.37	0.25V/100K	0.0970	1.50	78.34	53.48	0.25V/100K	0.387	0.75
STB1106250MZF	24.79	16.60	0.25V/100K	0.1090	1.40	99.14	66.38	0.25V/100K	0.436	0.70
STB1106330MZF	32.67	21.29	0.25V/100K	0.1260	1.30	130.70	85.17	0.25V/100K	0.503	0.65
STB1106500MZF	49.10	35.31	0.25V/100K	0.3050	0.82	196.38	141.24	0.25V/100K	1.221	0.41
STB1106680MZF	68.85	47.93	0.25V/100K	0.3620	0.76	275.40	191.71	0.25V/100K	1.445	0.38
STB1106101MZF	99.14	69.56	0.25V/100K	0.5410	0.62	396.58	278.22	0.25V/100K	2.162	0.31

* Turns Ratio : 1 : 1



RoHS Compliant

NOTE : Specifications subject to change without notice. Please check our website for latest information.

29.12.2014



SUPERWORLD ELECTRONICS (S) PTE LTD

7. CHARACTERISTICS CURVES :

@ TEMP. RISE VS. DC SUPERPOSITION RESPONSE CURVE (PARA)

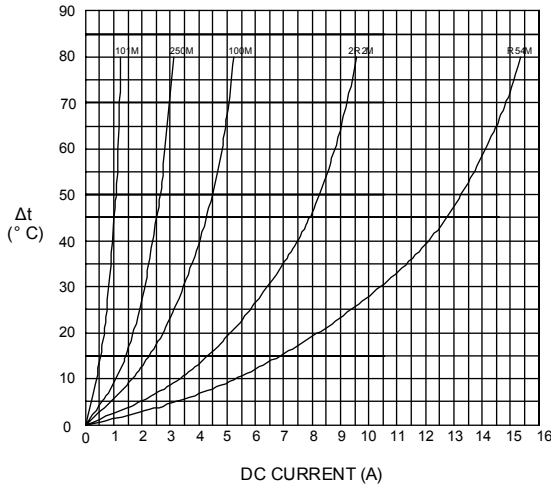

@ TEMP. RISE VS. DC SUPERPOSITION RESPONSE CURVE (SER)

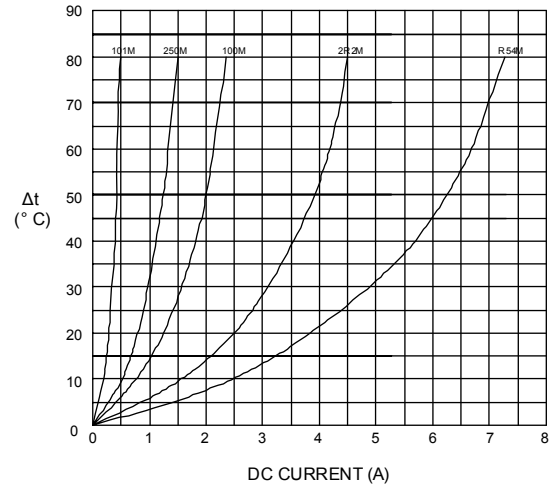

@ INDUCTANCE VS. DC SUPERPOSITION RESPONSE CURVE (PARA)

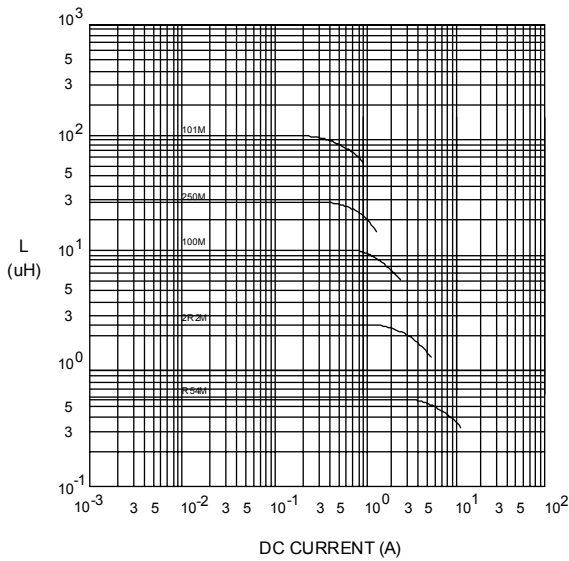

@ INDUCTANCE VS. DC SUPERPOSITION RESPONSE CURVE (SER)

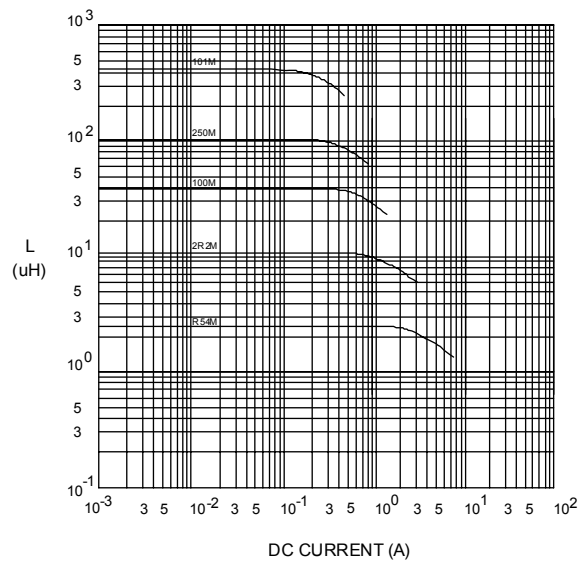

NOTE : Specifications subject to change without notice. Please check our website for latest information.



RoHS Compliant

29.12.2014



RECOMMENDED SOLDERING CONDITIONS REFLOW SOLDERINGS

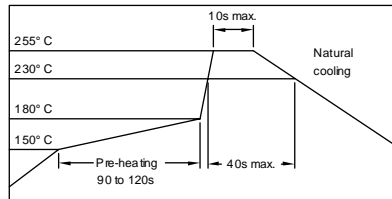

8. PACKAGING INFORMATION :

(1) CONFIGURATION

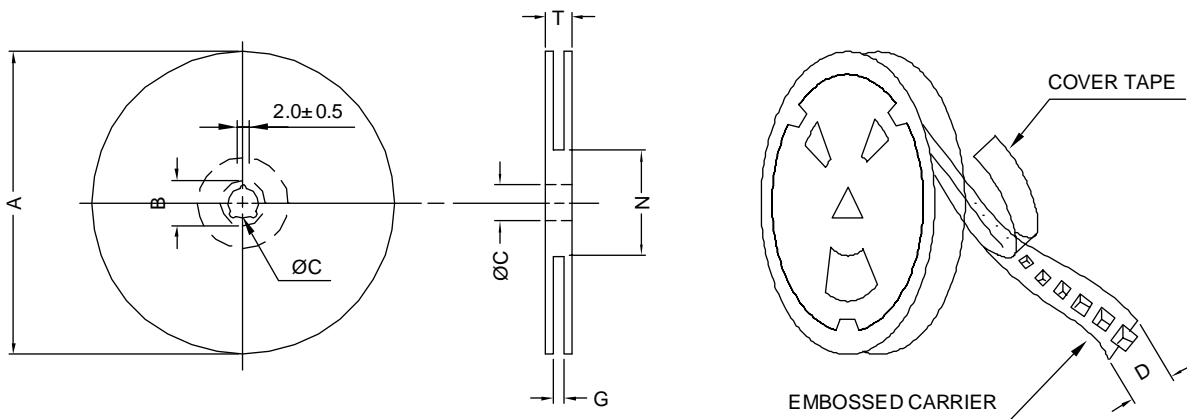

* CARRIER TAPE WIDTH : D

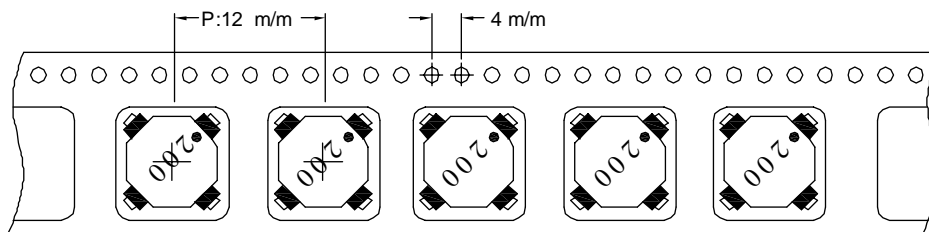

(2) DIMENSIONS

Unit:m/m

STYLE	A	B	C	D	G	N	T
13-24	330	21±0.8	13±0.5	24	26 ⁺⁰	50 ⁻⁰	30.4

(3) QTY & G.W. PER PACKAGE

SERIES	INNER : REEL			OUTER : CARTON		
	QTY (PCS)	G.W. (gw)	STYLE	QTY (PCS)	G.W. (Kg)	SIZE (cm)
STB1106	800	2100	13-24	3200	11.9	40 x 40 x 24



RoHS Compliant

NOTE : Specifications subject to change without notice. Please check our website for latest information.

29.12.2014



SUPERWORLD ELECTRONICS (S) PTE LTD