

1. Part No. Expression

PIM 252012AR33M

(a) (b) (c) (d) (e)

(a) Series Code

(d) Inductance Code

(b) Dimension Code

(e) Tolerance Code

(c) Material Code

2. Configuration & Dimensions (Unit: mm)

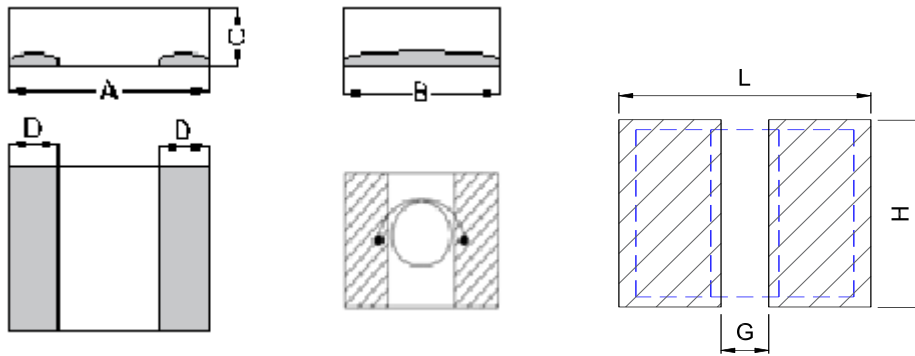

Recommended PCB Pattern

A	B	C	D	L	G	H
2.5 ± 0.3	2.0 ± 0.3	1.0 ± 0.2	0.9 ± 0.3	2.9 Ref	0.5 Ref	2.3 Ref

NOTE: Specifications subject to change without notice. Please check our website for latest information.

3. General Specifications

- (a) Operating Temp.: -40°C to +125°C (Including self-temperature rise).
- (b) Storage Temp.: -40°C to +125°C (On board).
- (c) Heat Rated Current (Irms) will cause the coil temperature rise approximately ΔT of 40°C.
- (d) Saturation Current (Isat) will cause L0 to drop approximately 30%.
- (e) Part Temperature (Ambient + Temp Rise): Should not exceed 125°C under worst case operating conditions.
- (f) Rated DC current: The less value which is Irms or Isat.
- (g) Rated voltage 25V DC. The application of voltage depends on many factors , Over voltage may cause components failure, high temperature and burn-out.
- (h) Storage condition (Component in its packaging)
 - i) Temperature: Less than 40°C
 - ii) Humidity: Less than 60% RH

4. Electrical Characteristics

Part Number	Inductance L0 A(uH) ±20%	Heat Rating Current DC Irms(A)		Saturation Current DC I sat (A)		DCR (mΩ) Typ	DCR (mΩ) Max	Operating Voltage (V) Max
		Typ	Max	Typ	Max			
PIM252012AR24M	0.24	7.3	6.8	7.8	7.2	11.0	13.2	15
PIM252012AR33M	0.33	6.8	6.3	7.5	6.8	14.0	17.0	15
PIM252012AR47M	0.47	6.2	5.6	6.2	5.6	15.0	18.0	15
PIM252012AR68M	0.68	5.3	4.9	5.5	5.0	23.0	27.6	15
PIM252012A1R0M	1.00	4.5	4.2	5.0	4.2	33.0	39.6	15
PIM252012A1R5M	1.50	3.7	3.4	4.0	3.5	43.0	51.6	15
PIM252012A2R2M	2.20	3.1	2.8	3.4	3.1	66.0	79.2	15
PIM252012A3R3M	3.30	2.4	2.2	3.0	2.7	115	138	15
PIM252012A4R7M	4.70	2.0	1.8	2.8	2.5	170	204	15

Note: Test frequency: 100kHz /1.0V. All test data referenced to 25°C ambient.

NOTE: Specifications subject to change without notice. Please check our website for latest information.

5. Characteristics Curves

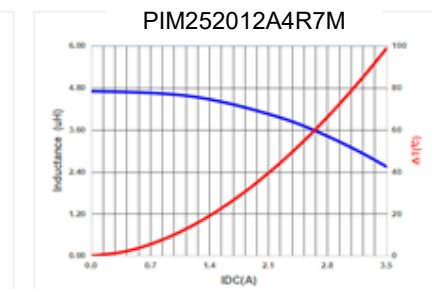
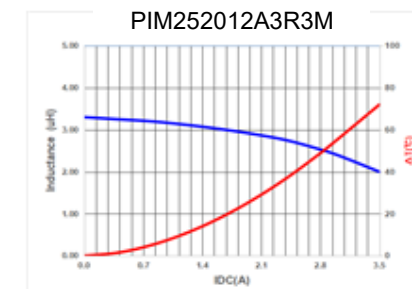
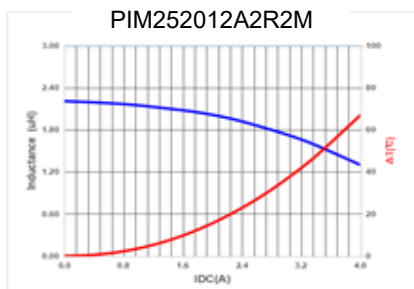
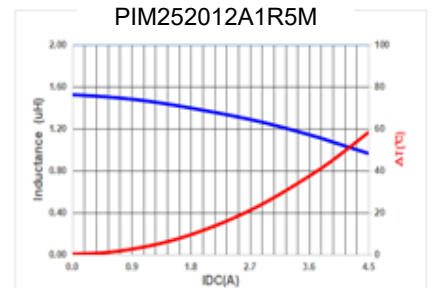
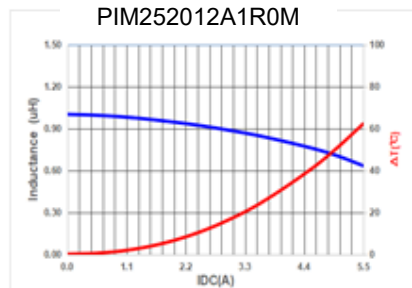
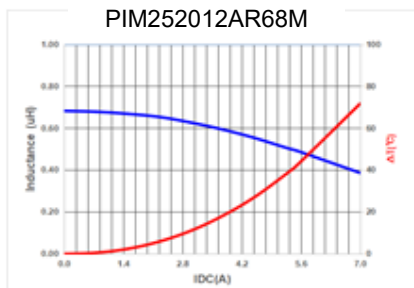
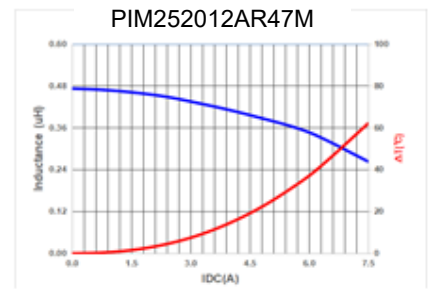
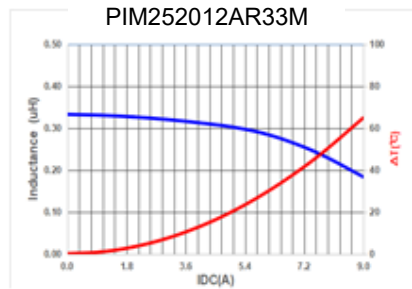
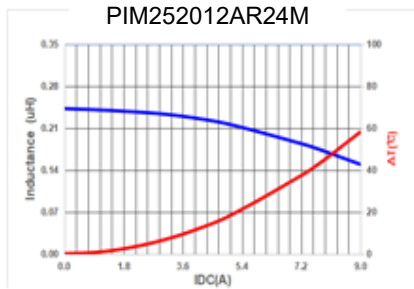

NOTE: Specifications subject to change without notice. Please check our website for latest information.

6. Soldering and Mounting

Mildly activated rosin fluxes are preferred. Our terminations are suitable for re-flow soldering systems. If hand soldering cannot be avoided, the preferred technique is the utilization of hot air soldering tools.

6-1 IR Soldering Reflow

Recommended temperature profiles for lead free re-flow soldering in Figure 1, Table 1.1 & 1.2 (J-STD-020E).

6-2 Iron Reflow

Products attachment with a soldering iron is discouraged due to the inherent process control limitations. In the event that a soldering iron must be employed the following precautions are recommended (Figure 2).

Note:

- Preheat circuit and products to 150°C.
- 280°C tip temperature (Max.)
- Never contact the ceramic with the iron tip
- 1.0mm tip diameter (Max.)
- Use a 20 watt soldering iron with tip diameter of 1.0mm
- Limit soldering time to 3 sec.

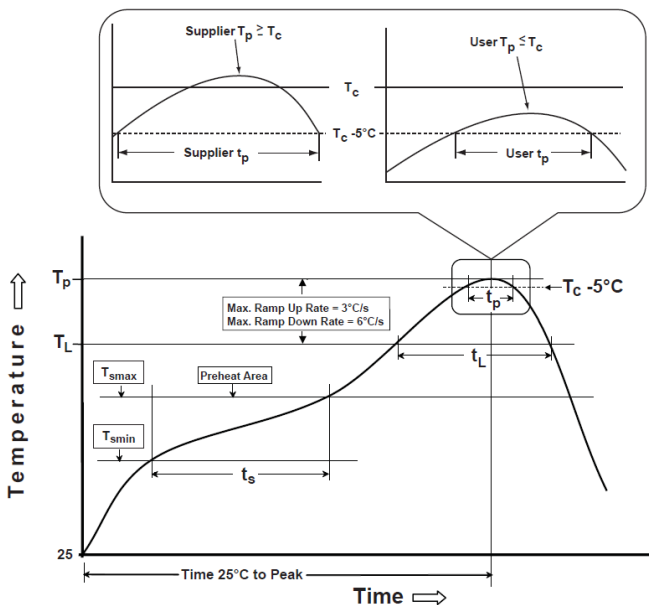

Reflow times: 3 times Max

Figure 1: IR Soldering Reflow

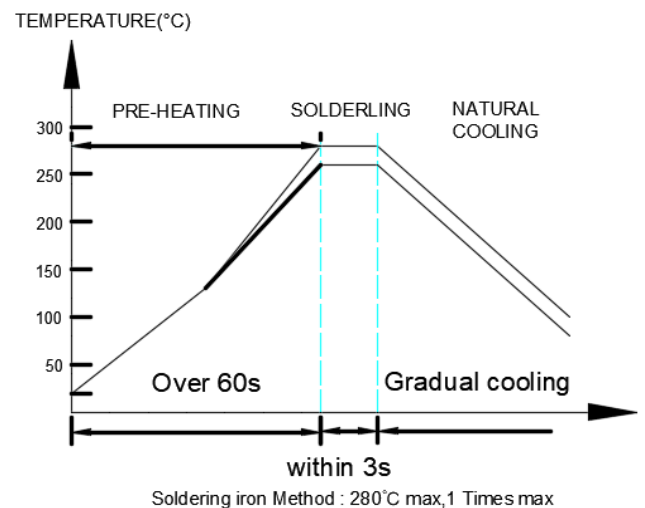

Soldering iron method: 280°C Max

Figure 2: Iron soldering temperature profiles

NOTE: Specifications subject to change without notice. Please check our website for latest information.

Table (1.1): Reflow Profiles

Profile Type:	Pb-Free Assembly
Preheat -Temperature Min (T_{smin}) -Temperature Max (T_{smax}) -Time (t_s) from (T_{smin} to T_{smax})	150°C 200°C 60-120seconds
Ramp-up rate (T_L to T_p)	3°C /second max.
Liquidus temperature (T_L) Time (t_L) maintained above T_L	217°C 60-150 seconds
Classification temperature (T_c)	See Table (1.2)
Time (t_p) at $T_c - 5^\circ\text{C}$ (T_p should be equal to or less than T_c .)	< 30 seconds
Ramp-down rate (T_p to T_L)	6°C /second max.
Time 25°C to peak temperature	8 minutes max.

T_p: maximum peak package body temperature, **T_c**: the classification temperature.

For user (customer) **T_p** should be equal to or less than **T_c**.

Table (1.2) Package Thickness/Volume and Classification Temperature (T_c)

	Package Thickness	Volume mm ³ <350	Volume mm ³ 350-2000	Volume mm ³ >2000
PB-Free Assembly	<1.6mm	260°C	260°C	260°C
	1.6-2.5mm	260°C	250°C	245°C
	≥2.5mm	250°C	245°C	245°C

Reflow is referred to standard IPC/JEDEC J-STD-020E.

NOTE: Specifications subject to change without notice. Please check our website for latest information.

7. Packaging Information

7-1 Reel Dimension

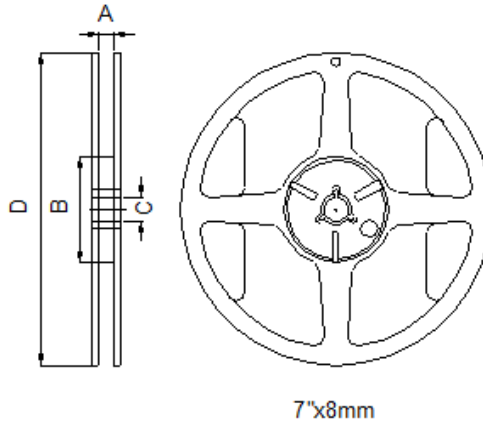

Type	A(mm)	B(mm)	C(mm)	D(mm)
7"x8mm	8.4+1.5/-0.0	60±1.0	13+0.5/-0.2	178±2.0

7-2 Tape Dimension

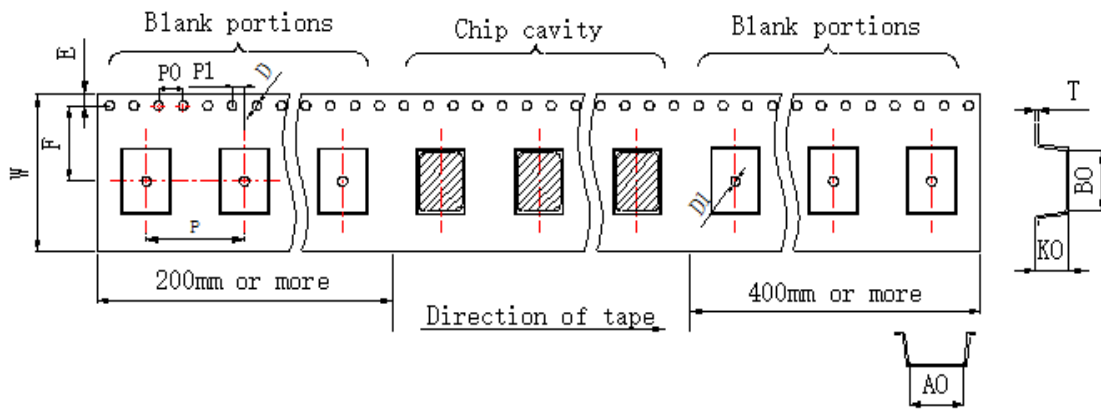

Series	Size	B0(mm)	A0(mm)	K0(mm)	W(mm)	P(mm)	P0(mm)
		2.9±0.1	2.45±0.1	1.35±0.1	8.0±0.1	4.0±0.1	4.0±0.1
PIM	252012A	P1(mm)	E(mm)	F(mm)	T(mm)	D/D1(mm)	
		2.0±0.1	1.75±0.1	3.5±0.1	0.24±0.05	1.5+0.1/-0.0	

NOTE: Specifications subject to change without notice. Please check our website for latest information.

7-3 Packaging Quantity

Chip Size	PIM252012A
Chip / Reel	2,000

7-4 Tearing Off Force

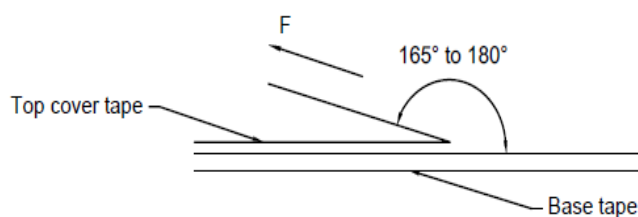

The force for tearing off cover tape is 10 to 100 grams in the arrow direction under the following conditions. (referenced ANSI/EIA-481-D-2008 of 4.11 standard).

Tearing Speed (mm/min)	Room Temp. (°C)	Room Humidity (%)	Room atm (hPa)
300±10	5~35	45~85	860~1060

Application Notice

1. Storage Conditions

To maintain the solderability of terminal electrodes:

- a) Recommended products should be used within 12 months from the time of delivery.
- b) The packaging material should be kept where no chlorine or sulfur exists in the air.

2. Transportation

- a) Products should be handled with care to avoid damage or contamination from perspiration and skin oils.
- b) The use of tweezers or vacuum pick up is strongly recommended for individual components.
- c) Bulk handling should ensure that abrasion and mechanical shock are minimized.

NOTE: Specifications subject to change without notice. Please check our website for latest information.