

1. Part No. Expression:

**PIFQ0703AR60MN**

(a) (b) (c) (d) (e)

a) Series Code

b) Dimension Code

c) Type Code

d) Inductance Code

e) Tolerance Code

2. Configuration & Dimensions:

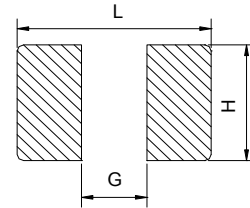
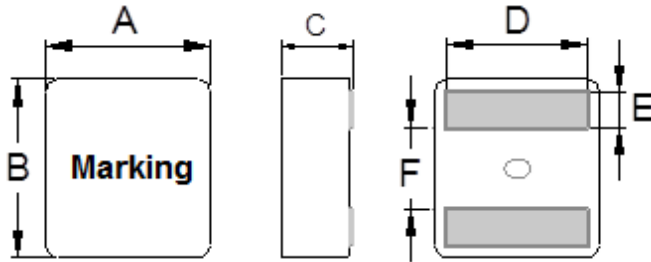

Note:

1. The above PCB layout is for reference only.
2. Solder paste thickness of 0.15mm and above is recommended.
3. Marking: Top row- Inductance code, Bottom row-YYWW

Recommended PC Board Pattern

Unit: mm

A	B	C	D	E	F	G	H	L
7.8±0.25	7.60±0.20	2.90±0.20	See Spec Table	1.75±0.20	3.15±0.25	2.8 Ref.	7.2 Ref.	7.4 Ref.

3. Schematic:

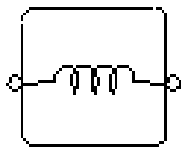

4. Material List:

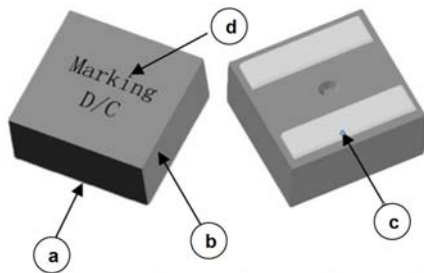

- (a) Core
- (b) Wire
- (c) Solder
- (d) Ink

NOTE: Specifications subject to change without notice. Please check our website for latest information.



**5. General Specification:**

- (a) Reliability test for this part meets AEC-Q200 standard
- (b) Operating Temp. : -55°C to +155°C (including self-temperature rise)
- (c) Storage Temp.: -55°C to +155°C (on board)
- (d) Humidity Range : 85 ± 3% RH
- (e) Heat Rated Current (Irms) will cause the coil temperature rise approximately Δt of 20°C & 40°C (see following table)
- (f) Saturation Current (Isat Typ.) will cause L0 to drop approximately 30%.
- (g) Part Temperature (Ambient + Temp. Rise): Should not exceed 155°C under worst case operating conditions.
- (h) Storage condition (component in its packaging)
  - i) Temperature: Less than 40°C
  - ii) Humidity: 60% RH

**6. Electrical Characteristics:**

Part Number	Inductance (uH) ±20% @ 0A	Test Frequency L	Irms (A) Typ.		Isat (A)		DCR (mΩ) Typ.	DCR (mΩ) Max.	D (mm) ±0.3
			20°C rise	40°C rise	Typ.	Max.			
PIFQ0703AR60MN	0.60	100KHz/0.1V	18.0	23.0	36.0	32.0	2.90	3.20	6.6
PIFQ0703A1R0MN	1.00	100KHz/0.1V	16.1	21.8	30.0	28.0	4.55	5.00	6.6
PIFQ0703A1R5MN	1.50	100KHz/0.1V	12.0	15.3	25.0	23.5	7.50	8.25	6.6
PIFQ0703A2R2MN	2.20	100KHz/0.1V	10.0	13.0	19.0	17.0	12.4	13.7	6.2
PIFQ0703A2R7MN	2.70	100KHz/0.1V	9.20	11.4	16.0	13.5	14.0	15.4	6.2
PIFQ0703A3R3MN	3.30	100KHz/0.1V	8.00	10.0	15.0	13.0	16.3	18.0	6.2
PIFQ0703A4R7MN	4.70	100KHz/0.1V	6.90	9.00	13.5	12.2	24.2	26.7	6.2
PIFQ0703A5R6MN	5.60	100KHz/0.1V	5.30	7.30	12.5	11.5	30.1	33.2	6.2
PIFQ0703A6R8MN	6.80	100KHz/0.1V	4.50	6.80	12.0	11.0	38.6	42.5	6.2
PIFQ0703A8R2MN	8.20	100KHz/0.1V	3.00	5.90	10.2	9.0	44.3	48.73	6.2

Notes:

- 1) Isat Typ. and Irms Typ. value is derived based from accounting the upper limit tolerance into the inductance value.
- 2) At all times, the current supplied to the product should not exceed Isat Max. value.

NOTE: Specifications subject to change without notice. Please check our website for latest information.

7. Characteristics Curves :

PIFQ0703AR60MN

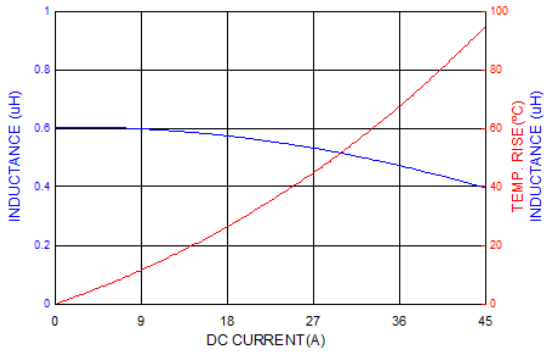

PIFQ0703A1R0MN

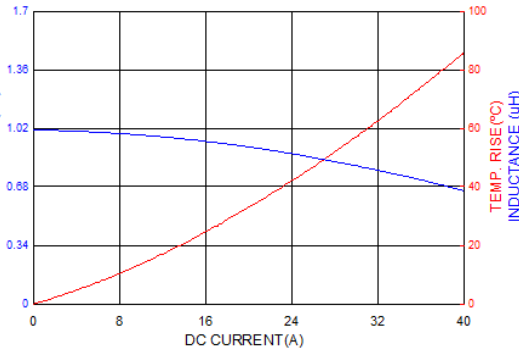

PIFQ0703A1R5MN

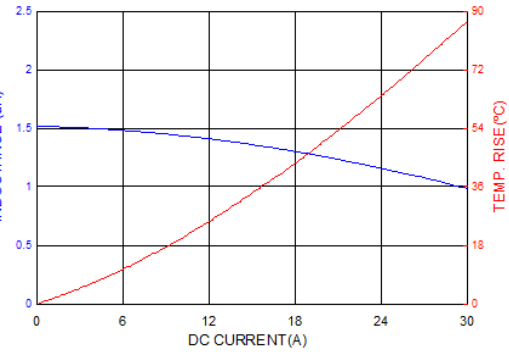

PIFQ0703A2R2MN

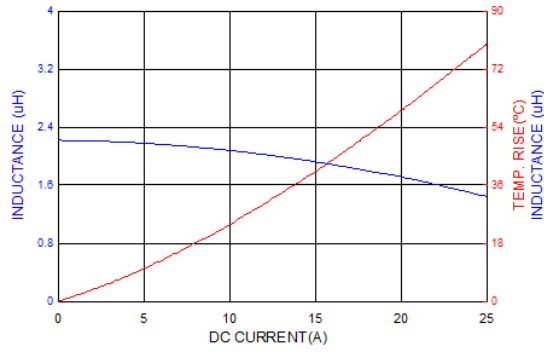

PIFQ0703A2R7MN

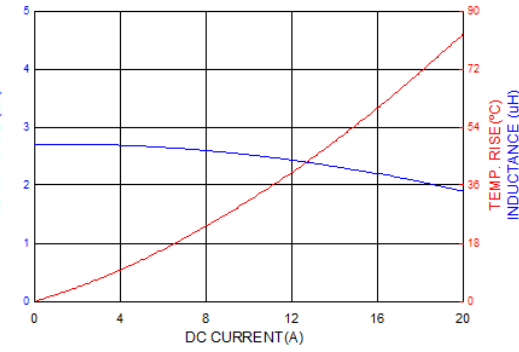

PIFQ0703A3R3MN

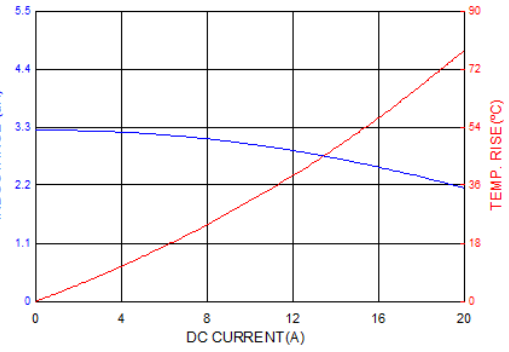

PIFQ0703A4R7MN

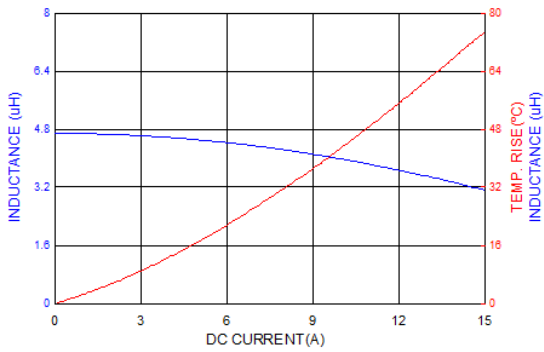

PIFQ0703A5R6MN

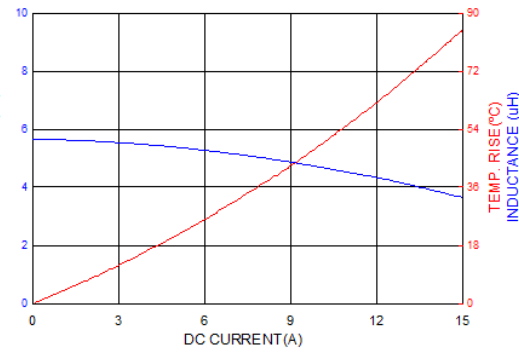

PIFQ0703A6R8MN

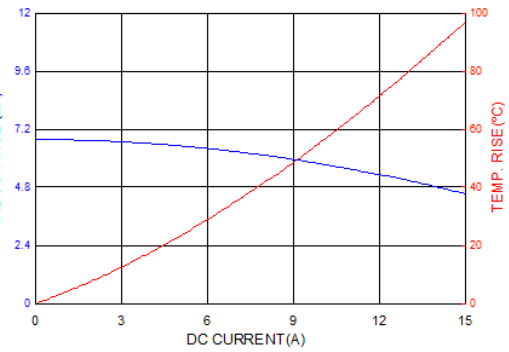

PIFQ0703A8R2MN

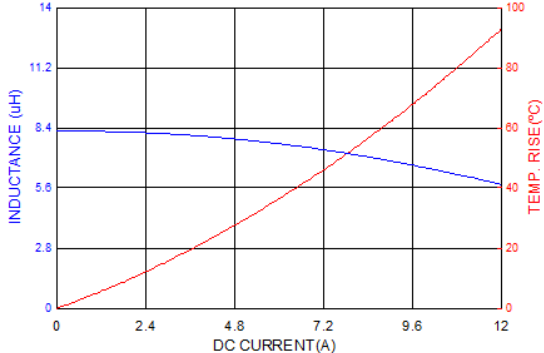

NOTE: Specifications subject to change without notice. Please check our website for latest information.



**8. Soldering:**

Mildly activated rosin fluxes are preferred. The minimum amount of solder can lead to damage from the stresses caused by the difference in coefficients of expansion between solder, chip and substrate. Our terminations are suitable for all re-flow soldering systems. If hand soldering cannot be avoided, the preferred technique is the utilization of hot air.

**8-1 Solder Re-flow:**

Recommended temperature profiles for re-flow soldering in Figure 1.

**8-2 Soldering Iron (Figure 2):**

Products attachment with soldering iron is discouraged due to the inherent process control limitations. In the event that a soldering iron must be employed the following precautions are recommended.

Note :

- a) Preheat circuit and products to 150°C.
- b) 355°C tip temperature (Max.)
- c) Never contact the ceramic with the iron tip
- d) 1.0mm tip diameter (Max.)
- e) Use a 20 watt soldering iron with tip diameter of 1.0mm
- f) Limit soldering time to 4~5 secs.

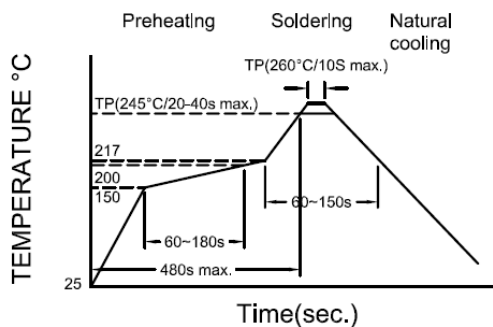

Reflow times: 3 times max

Fig.1

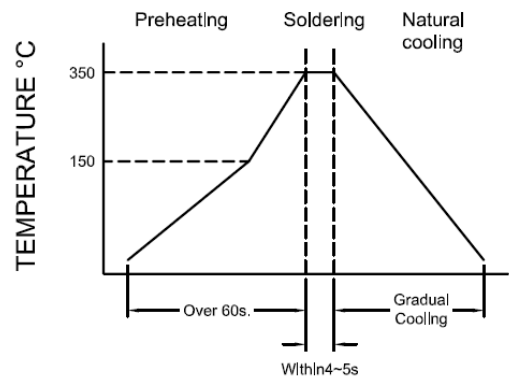

Iron Soldering times: 1 times max

Fig.2

NOTE: Specifications subject to change without notice. Please check our website for latest information.



9. Packaging Information:

9-1 Reel Dimension

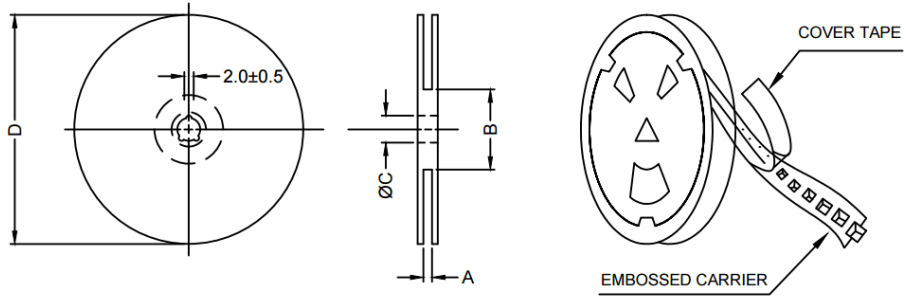

Type	A(mm)	B(mm)	C(mm)	D(mm)
13"x16mm	16.4+2/-0	100±2	13+0.5/-0.2	330

9-2 Tape Dimension

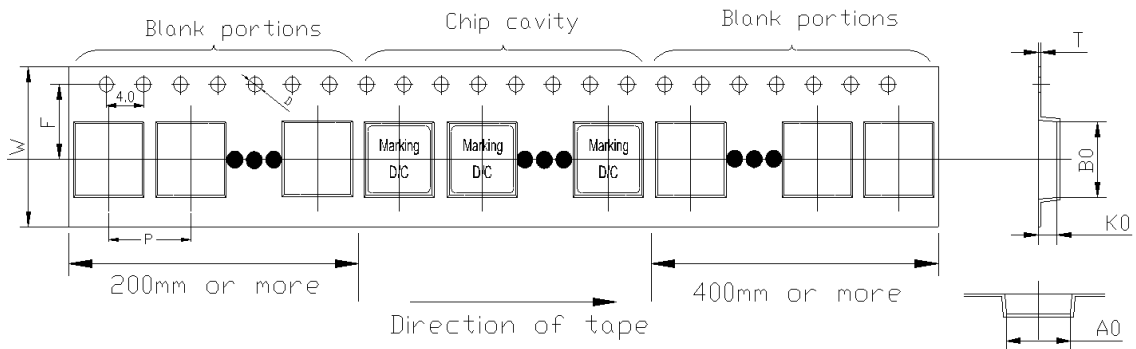

Series	Size	Ao(mm)	Bo(mm)	Ko(mm)	P(mm)	W(mm)	F(mm)	T(mm)	D(mm)
PIFQ	0703	8.2±0.1	8.0±0.1	3.3±0.1	12.0±0.1	16.0±0.3	7.5±0.1	0.35±0.1	1.5±0.1

9-3 Packaging Quantity

PIFQ	0703A
Chip / Reel	1500
Inner box	3000
Carton	12000

NOTE: Specifications subject to change without notice. Please check our website for latest information.

## 9-4 Tearing Off Force

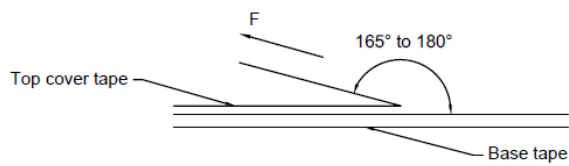

The force for tearing off cover tape is 10 to 130 grams in the arrow direction under the following conditions

Room Temp. (°C)	Room Humidity (%)	Room atm (hPa)	Tearing Speed mm/min
5~35	45~85	860~1060	300

## **Application Notice:**

### 1. Storage Conditions:

To maintain the solderability of terminal electrodes:

- a) Recommended products should be used within 12 months from the time of delivery.
- b) The packaging material should be kept where no chlorine or sulfur exists in the air.

### 2. Transportation:

- a) Products should be handled with care to avoid damage or contamination from perspiration and skin oils.
- b) Vacuum pick up is strongly recommended for individual components.
- c) Bulk handling should ensure that abrasion and mechanical shock are minimized.

NOTE: Specifications subject to change without notice. Please check our website for latest information.