

SMD Power Choke Coil

PIC0318H SERIES

1. PART NO. EXPRESSION :

P I C 0 3 1 8 H R 5 6 M F -

(a) (b) (c) (d) (e)(f) (g)

(a) Series code

(b) Dimension code

(c) Type code

(d) Inductance code : R56 = 0.56uH

(e) Tolerance code : M = $\pm 20\%$, Y = $\pm 30\%$

(f) F : RoHS Compliant

(g) 11-99 : Internal control number

2. CONFIGURATION & DIMENSIONS :

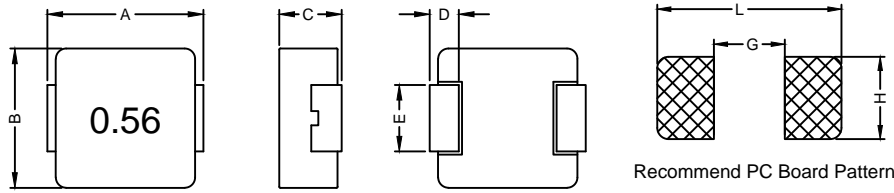

Recommend PC Board Pattern

Unit:m/m

A	B	C	D	E	G	H	L
3.5 \pm 0.3	3.2 \pm 0.2	1.6 \pm 0.2	0.7 \pm 0.2	1.2 \pm 0.2	1.9	1.45	4.1

3. SCHEMATIC :

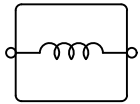

4. MATERIALS :

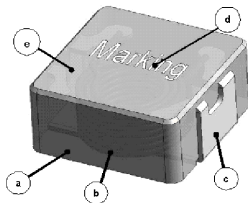

(a) Core

(b) Wire

(c) Terminal

(d) Ink

(e) Paint



RoHS Compliant

NOTE : Specifications subject to change without notice. Please check our website for latest information.

09.11.2015



SUPERWORLD ELECTRONICS (S) PTE LTD

PG. 1

5. GENERAL SPECIFICATION :

- a) Test Freq. : L : 100KHz/1.0V
- b) Operating Temp. : -40°C to +125°C
- c) Storage Temp. : -40°C to +125°C
- d) Humidity Range : 85 ± 3% RH
- e) Heat Rated Current (Irms) will cause the coil temperature rise approximately Δt of 40°C (keep 1min)
- f) Saturation Current (Isat) will cause L0 to drop 30%.
- g) Part Temperature (Ambient+Temp. Rise) : Should not exceed 125°C under worst case operating conditions.
- h) Storage condition (component in its packaging)
 - i) Temperature: -10 to 40°C
 - ii) Humidity : 50~60% RH

6. ELECTRICAL CHARACTERISTICS :

Part No.	Inductance L ₀ (μH) @ 0 A	Irms(A) Typ.	Isat(A) Typ.	DCR (mΩ) Typ. @ 25°C	DCR (mΩ) Max. @ 25°C
PIC0318HR47MF	0.47	6	8.5	21.5	25
PIC0318HR56MF	0.56	5	8	21	26
PIC0318HR68MF	0.68	5	6.5	29	33.5
PIC0318H1R0MF	1.00	3.8	5	38	44
PIC0318H1R5MF	1.50	3.5	4	56	65
PIC0318H2R2MF	2.20	3.3	3.7	73	85
PIC0318H3R3MF	3.30	2.7	3.3	136	158
PIC0318H4R7MF	4.70	2.3	2.9	180	208
PIC0318H5R6MF	5.60	1.9	2.3	238	275
PIC0318H6R8MF	6.80	1.5	2.1	275	320
PIC0318H8R2MF	8.20	1.4	1.9	350	405
PIC0318H100MF	10.0	1.3	1.6	375	450
PIC0318H150MF	15.0	1.2	1.5	520	600

Tolerance code : M = ±20%, Y = ±30%



RoHS Compliant

NOTE : Specifications subject to change without notice. Please check our website for latest information.

09.11.2015



SUPERWORLD ELECTRONICS (S) PTE LTD

7. CHARACTERISTICS CURVES :

PIC0318HR47MF

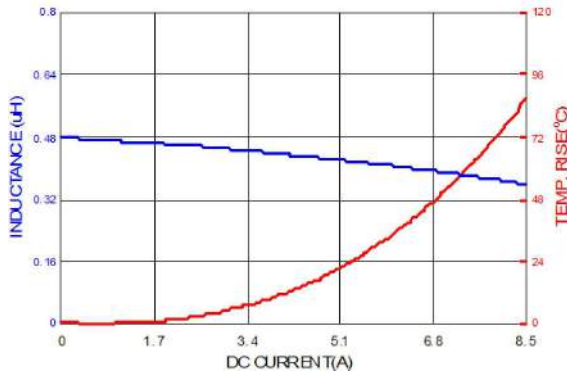

PIC0318HR56MF

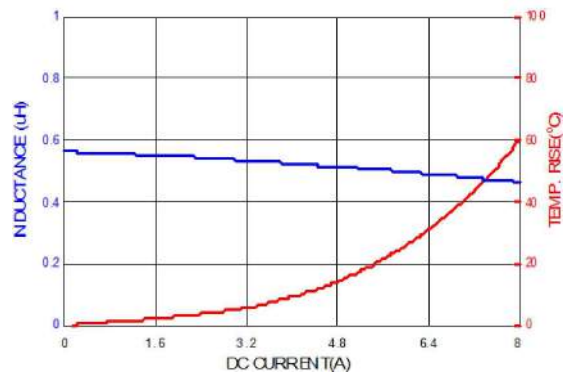

PIC0318HR68MF

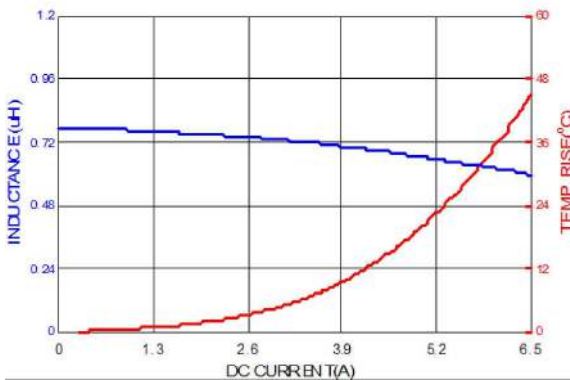

PIC0318H1R0MF

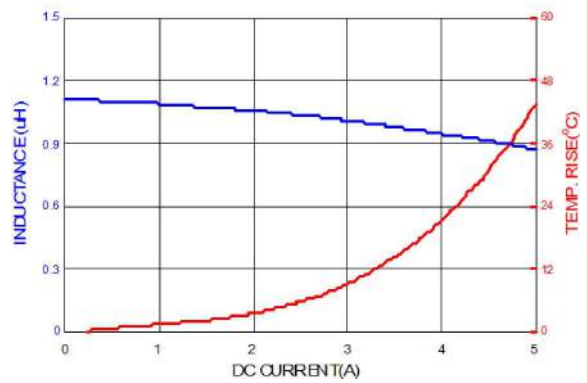

PIC0318H1R5MF

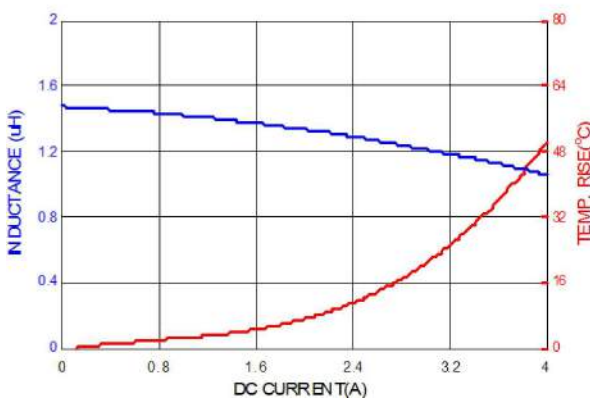

PIC0318H2R2MF

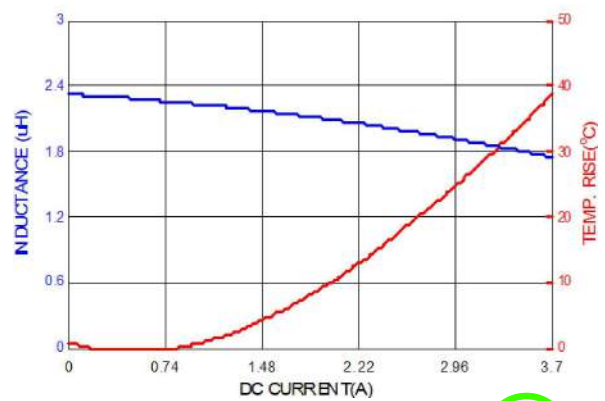

RoHS Compliant

NOTE : Specifications subject to change without notice. Please check our website for latest information.

09.11.2015



SUPERWORLD ELECTRONICS (S) PTE LTD

PIC0318H3R3MF

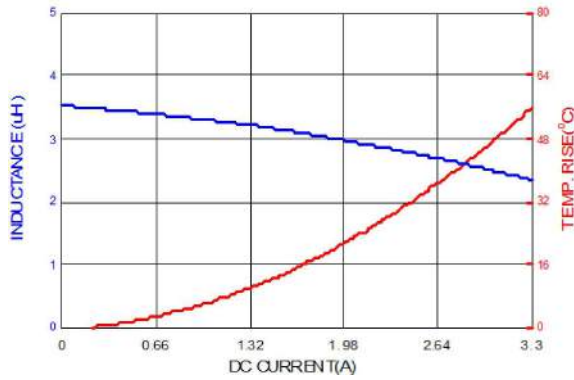

PIC0318H4R7MF

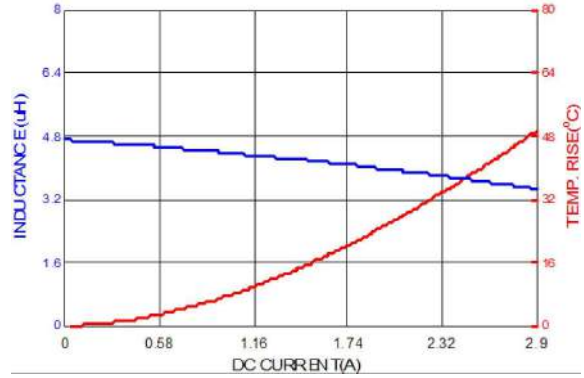

PIC0318H5R6MF

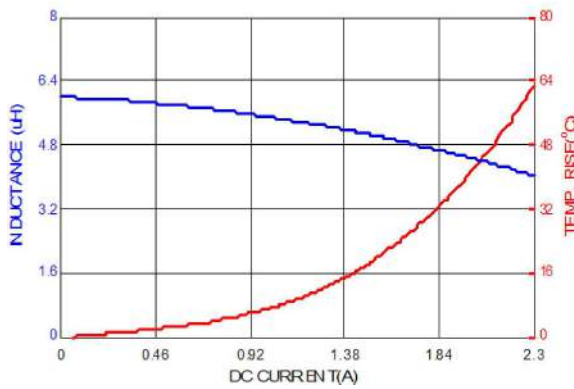

PIC0318H6R8MF

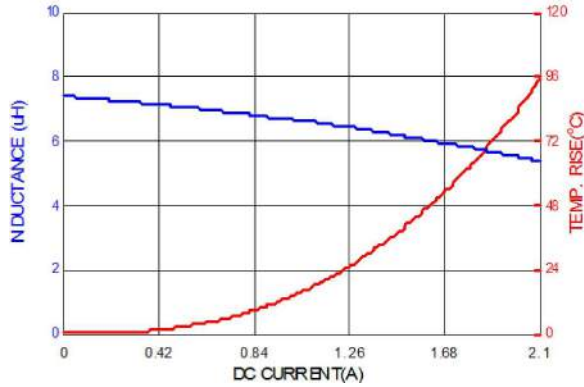

PIC0318H8R2MF

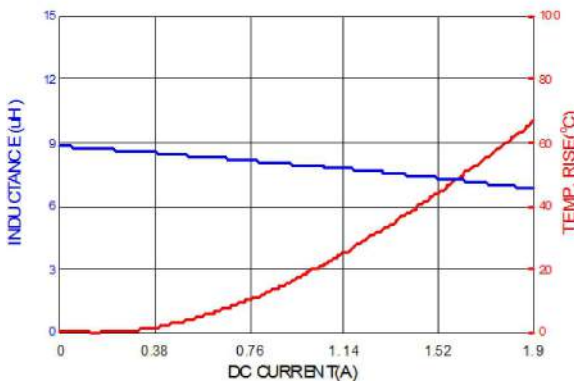

PIC0318H100MF

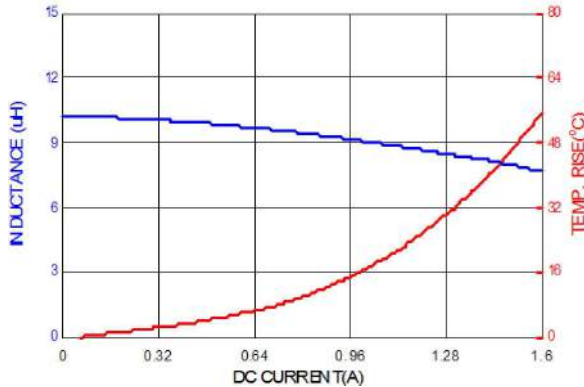

RoHS Compliant

NOTE : Specifications subject to change without notice. Please check our website for latest information.

09.11.2015



SUPERWORLD ELECTRONICS (S) PTE LTD

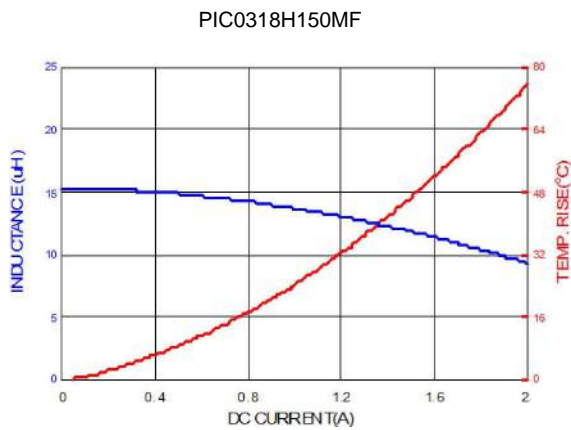

RoHS Compliant

NOTE : Specifications subject to change without notice. Please check our website for latest information.

09.11.2015



SUPERWORLD ELECTRONICS (S) PTE LTD

8. SOLDERING:

Mildly activated rosin fluxes are preferred. The minimum amount of solder can lead to damage from the stresses caused by the difference in coefficients of expansion between solder, chip and substrate. Our terminations are suitable for re-flow soldering systems. If hand soldering cannot be avoided, the preferred technique is the utilization of hot air soldering tools

8-1.1 Solder Re-flow :

Recommended temperature profiles for re-flow soldering in Figure 1.

8-1.2 Soldering Iron :

Products attachment with soldering iron is discouraged due to the inherent process control limitations. In the event that a soldering iron must be employed the following precautions are recommended.

Note :

- a) Preheat circuit and products to 150°C.
- b) 355°C tip temperature (max)
- c) Never contact the ceramic with the iron tip
- d) 1.0mm tip diameter (max)
- e) Use a 20 watt soldering iron with tip diameter of 1.0mm
- f) Limit soldering time to 4~5 secs.

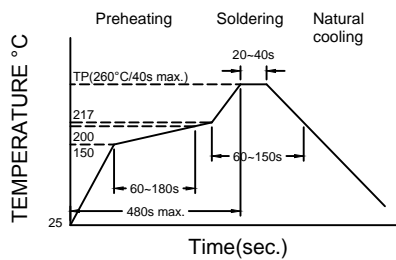

Figure 1. Re-flow Soldering: 3 times max.

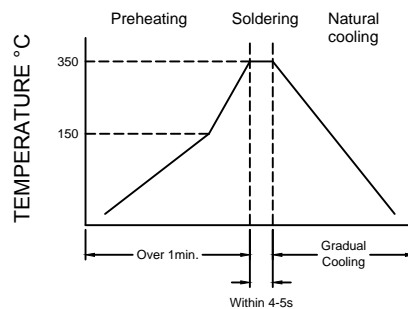

Figure 2. Iron Soldering: 1 times max.



RoHS Compliant

NOTE : Specifications subject to change without notice. Please check our website for latest information.

09.11.2015



SUPERWORLD ELECTRONICS (S) PTE LTD

9. PACKAGING INFORMATION :

9-1. Reel Dimension

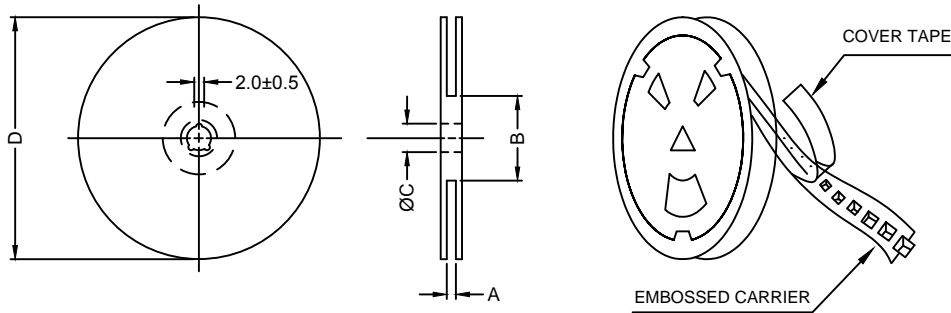

Type	A(mm)	B(mm)	C(mm)	D(mm)
13" x 12mm	12.4+2/-0	100±2.0	13.5±0.5	330

9-2. Tape Dimension

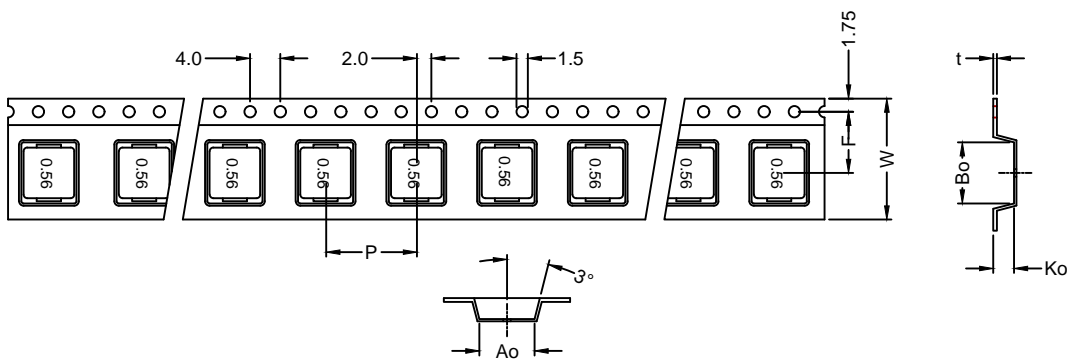

Series	Ao(mm)	Bo(mm)	Ko(mm)	P(mm)	W(mm)	F(mm)	t(mm)
PIC0318H	3.5±0.1	4.0±0.1	2.0±0.1	8.0±0.1	12.0±0.3	5.5±0.1	0.35±0.05

9-3. Packaging Quantity

Size	PIC0318H
Chip / Reel	3000
Inner Box	6000
Carton	24000



RoHS Compliant

NOTE : Specifications subject to change without notice. Please check our website for latest information.

09.11.2015



SUPERWORLD ELECTRONICS (S) PTE LTD

9-4. Tearing Off Force

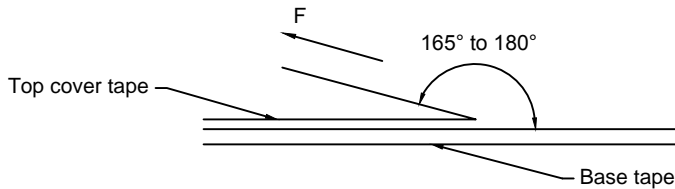

The force for tearing off cover tape is 10 to 130 grams in the arrow direction under the following conditions. (referenced ANSI/EIA-481-C-2003 of 4.11 standard)

Room Temp. (°C)	Room Humidity (%)	Room atm (hPa)	Tearing Speed (mm/min)
5~35	45~85	860~1060	300

Application Notice

1. Storage Conditions :

To maintain the solderability of terminal electrodes :

- a) Recommended products should be used within 12 months from the time of delivery.
- b) The packaging material should be kept where no chlorine or sulfur exists in the air.

2. Transportation :

- a) Products should be handled with care to avoid damage or contamination from perspiration and skin oils.
- b) Vacuum pick up is strongly recommended for individual components.
- c) Bulk handling should ensure that abrasion and mechanical shock are minimized.



RoHS Compliant

NOTE : Specifications subject to change without notice. Please check our website for latest information.

09.11.2015



SUPERWORLD ELECTRONICS (S) PTE LTD