

1. PART NO. EXPRESSION :

P I C 0 3 0 2 H 1 R 5 M F - □ □
 (a) (b) (c) (d) (e)(f) (g)

- (a) Series code
- (b) Dimension code
- (c) Type code

- (d) Inductance code : 1R5 = 1.5uH
- (e) Tolerance code : M = ±20%, Y = ±30%
- (f) F : RoHS Compliant
- (g) 11~99 : Internal control number

2. CONFIGURATION & DIMENSIONS :

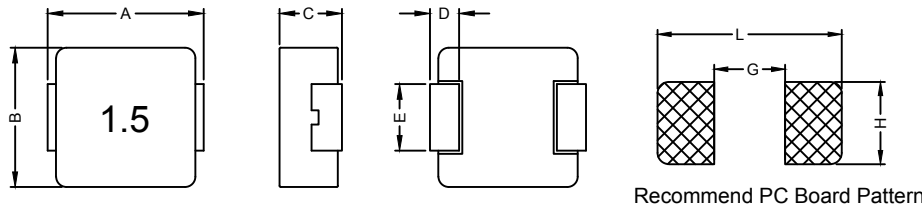

Unit:m/m

A	B	C	D	E	G	H	L
3.5±0.2	3.2±0.2	1.8±0.2	0.7±0.2	1.2±0.2	1.9	1.45	4.1

3. SCHEMATIC :

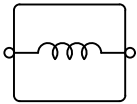

4. MATERIALS :

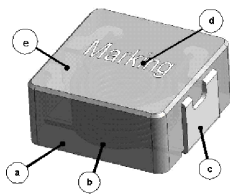

- (a) Core
- (b) Wire
- (c) Terminal
- (d) Ink
- (e) Paint



RoHS Compliant

NOTE : Specifications subject to change without notice. Please check our website for latest information.

13.09.2016

5. GENERAL SPECIFICATION :

- a) Test Freq. : L : 100KHz/1.0V
- b) Operating Temp. : -40°C to +125°C
- c) Storage Temp. : -40°C to +125°C
- d) Humidity Range : 85 ± 3% RH
- e) Heat Rated Current (Irms) will cause the coil temperature rise approximately Δt of 40°C (keep 1min)
- f) Saturation Current (Isat) will cause L0 to drop 30%.
- g) Part Temperature (Ambient+Temp. Rise) : Should not exceed 125°C under worst case operating conditions.
- h) Storage condition (component in its packaging)
 - i) Temperature: -10 to 40°C
 - ii) Humidity : 50~60% RH

6. ELECTRICAL CHARACTERISTICS :

Part No.	Inductance L ₀ (μH) @ 0 A	Irms (A) Typ.	Isat (A) Typ.	DCR (mΩ) Typ. @ 25°C	DCR (mΩ) Max. @ 25°C
PIC0302HR10YF	0.10	10.5	14.0	6.6	9.0
PIC0302HR22YF	0.22	9.0	11.2	11	14
PIC0302HR33MF	0.33	8.0	10.0	17	21
PIC0302HR47MF	0.47	7.0	9.0	19.7	23
PIC0302HR68MF	0.68	5.5	7.0	25.5	29
PIC0302HR82MF	0.82	4.8	6.0	27	32
PIC0302H1R0MF	1.00	4.0	5.0	32	38
PIC0302H1R5MF	1.50	3.8	4.0	42	50
PIC0302H2R2MF	2.20	3.5	3.7	65	75
PIC0302H3R3MF	3.30	3.0	3.5	125	145
PIC0302H4R7MF	4.70	2.6	3.0	172	200
PIC0302H5R6MF	5.60	2.2	2.6	205	238
PIC0302H6R8MF	6.80	1.9	2.2	260	300
PIC0302H8R2MF	8.20	1.6	1.9	340	390
PIC0302H100MF	10.0	1.4	1.6	366	422

Tolerance code : M = ±20%, Y = ±30%



RoHS Compliant

NOTE : Specifications subject to change without notice. Please check our website for latest information.

13.09.2016



SUPERWORLD ELECTRONICS (S) PTE LTD

7. CHARACTERISTICS CURVES :

PIC0302HR10YF

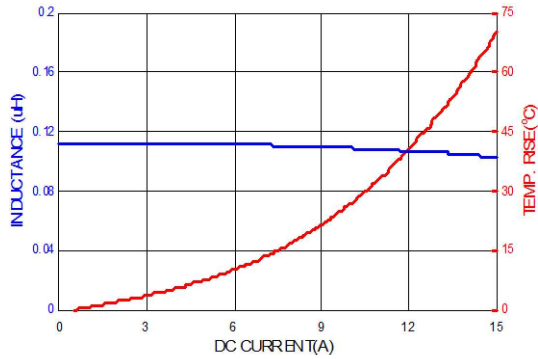

PIC0302HR22YF

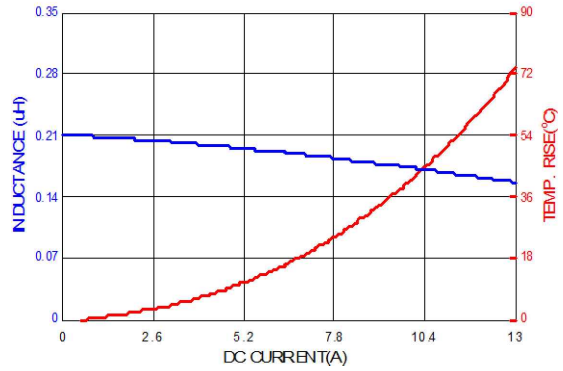

PIC0302HR33MF

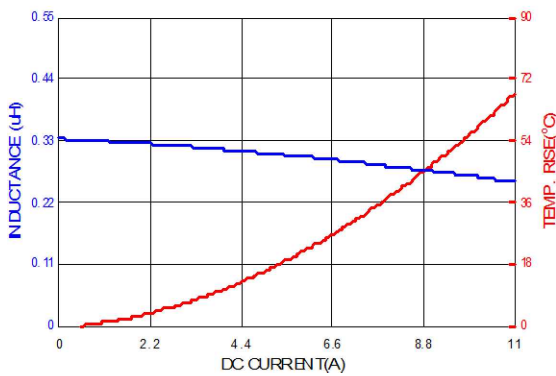

PIC0302HR47MF

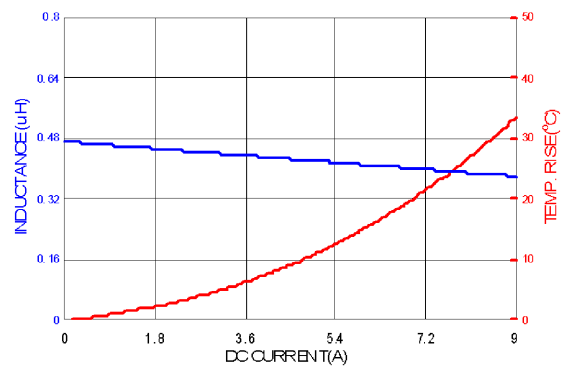

PIC0302HR68MF

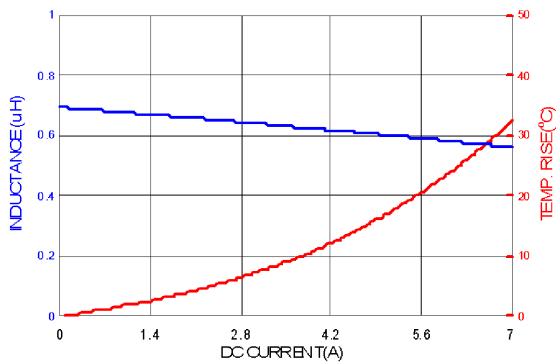

PIC0302HR82MF

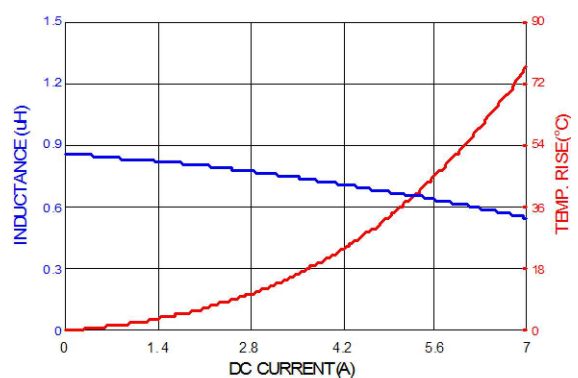

RoHS Compliant

NOTE : Specifications subject to change without notice. Please check our website for latest information.

13.09.2016



SUPERWORLD ELECTRONICS (S) PTE LTD

PIC0302H1R0MF

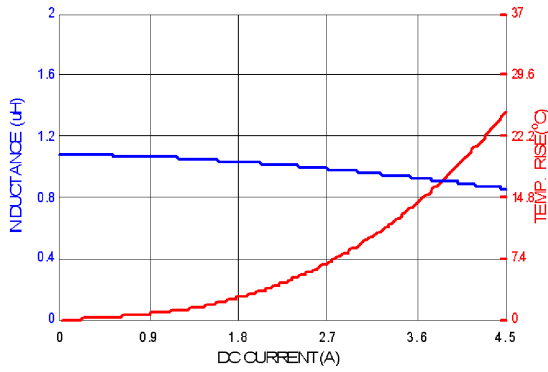

PIC0302H1R5MF

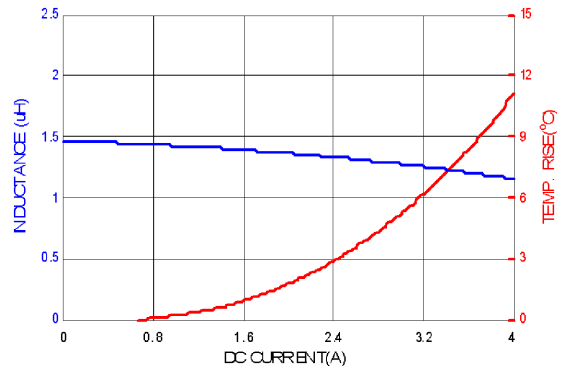

PIC0302H2R2MF

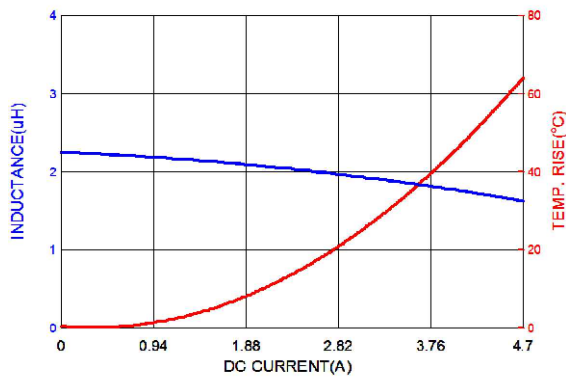

PIC0302H3R3MF

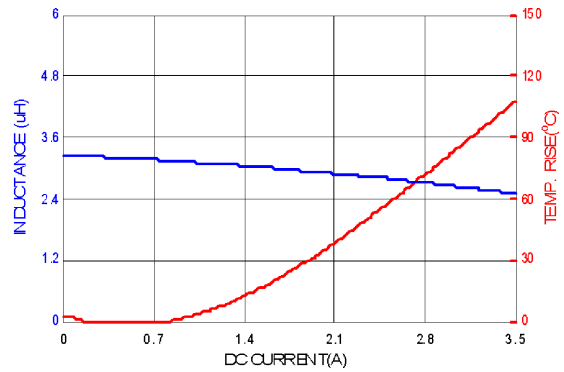

PIC0302H4R7MF

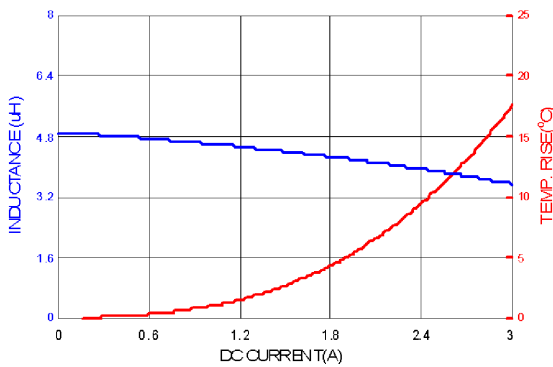

PIC0302H5R6MF

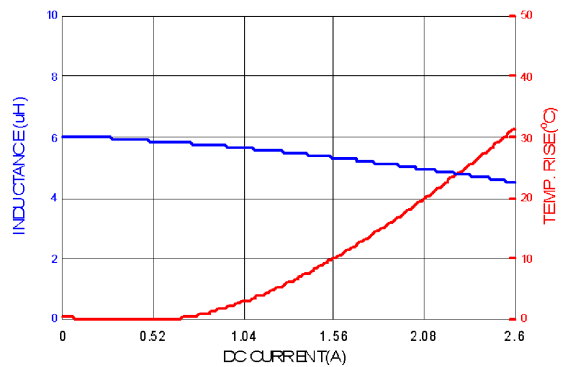

RoHS Compliant

NOTE : Specifications subject to change without notice. Please check our website for latest information.

13.09.2016



SUPERWORLD ELECTRONICS (S) PTE LTD

PIC0302H6R8MF

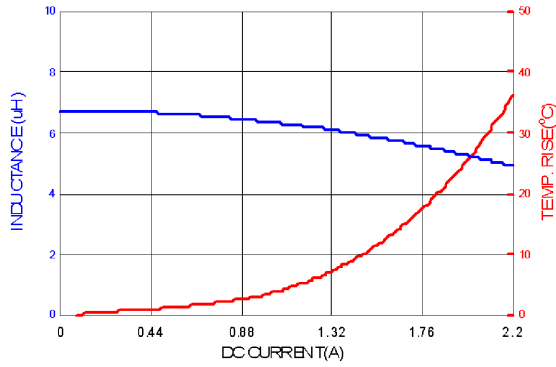

PIC0302H8R2MF

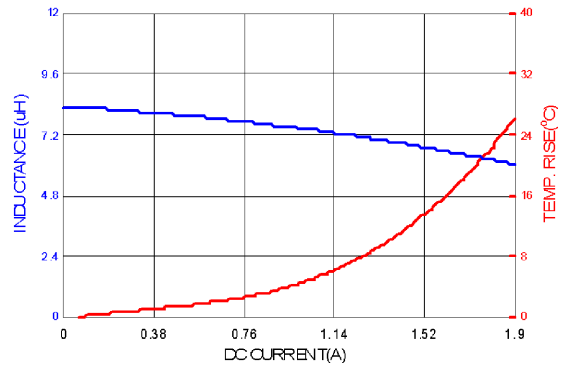

PIC0302H100MF

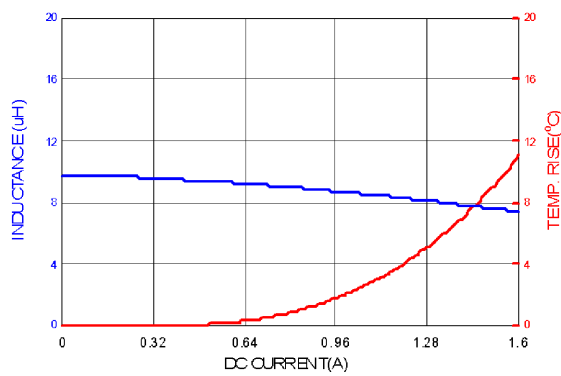

RoHS Compliant

NOTE : Specifications subject to change without notice. Please check our website for latest information.

13.09.2016

8. SOLDERING

Mildly activated rosin fluxes are preferred. The minimum amount of solder can lead to damage from the stresses caused by the difference in coefficients of expansion between solder, chip and substrate. Our terminations are suitable for all re-flow soldering systems. If hand soldering cannot be avoided, the preferred technique is the utilization of hot air soldering tools.

8-1.1 Solder Re-flow :

Recommended temperature profiles for re-flow soldering in Figure 1.

8-1.2 Soldering Iron (Figure 2) :

Products attachment with soldering iron is discouraged due to the inherent process control limitations. In the event that a soldering iron must be employed the following precautions are recommended.

Note :

- a) Preheat circuit and products to 150°C.
- b) 355°C tip temperature (max)
- c) Never contact the ceramic with the iron tip
- d) 1.0mm tip diameter (max)
- e) Use a 20 watt soldering iron with tip diameter of 1.0mm
- f) Limit soldering time to 4~5 secs.

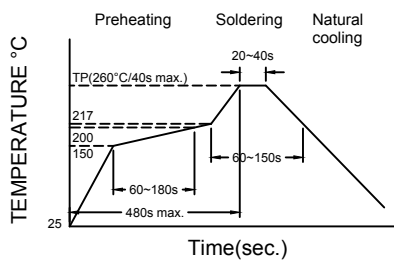

Figure 1. Re-flow Soldering: 3 times max.

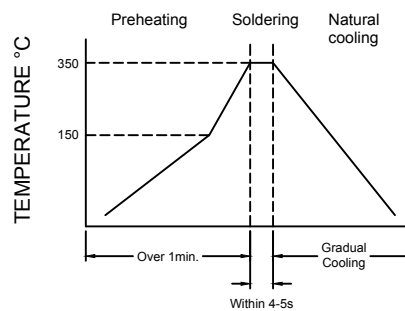

Figure 2. Hand Soldering: 1 times max.



RoHS Compliant

NOTE : Specifications subject to change without notice. Please check our website for latest information.

13.09.2016



SUPERWORLD ELECTRONICS (S) PTE LTD

9. PACKAGING INFORMATION :

9-1. Reel Dimension

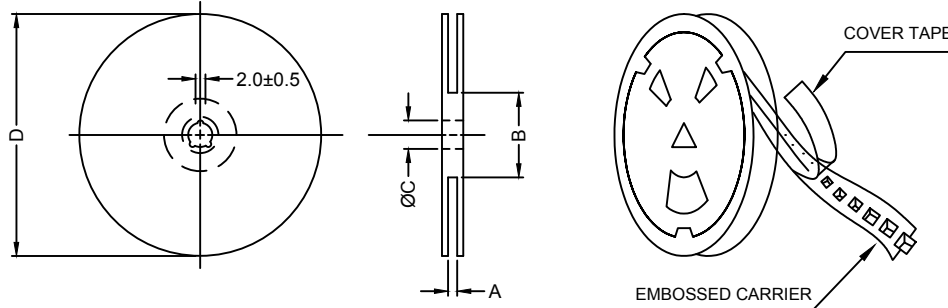

Type	A(mm)	B(mm)	C(mm)	D(mm)
13" x 12mm	12.0±0.5	100±2.0	13.5±0.5	330

9-2. Tape Dimension

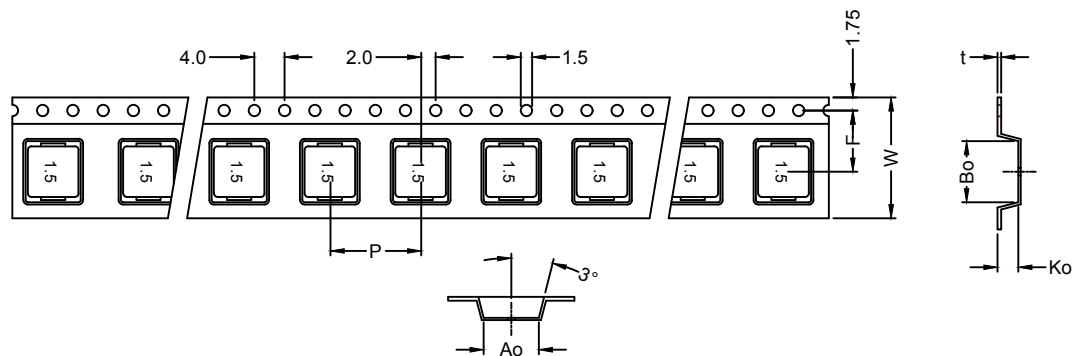

Series	Ao(mm)	Bo(mm)	Ko(mm)	P(mm)	W(mm)	F(mm)	t(mm)
PIC0302	3.5±0.1	3.8±0.1	2.3±0.1	8.0±0.1	12.0±0.3	5.5±0.1	0.35±0.05

9-3. Packaging Quantity

Size	PIC0302
Chip / Reel	3000
Inner Box	6000
Carton	24000



RoHS Compliant

NOTE : Specifications subject to change without notice. Please check our website for latest information.



9-4. Tearing Off Force

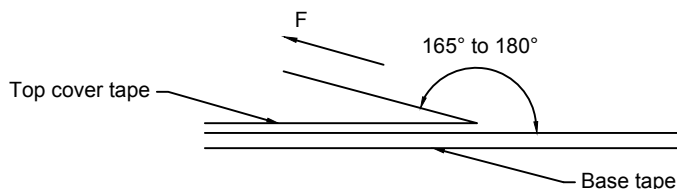

The force for tearing off cover tape is 10 to 130 grams in the arrow direction under the following conditions. (referenced ANSI/EIA-481-C-2003 of 4.11 standard)

Room Temp. (°C)	Room Humidity (%)	Room atm (hPa)	Tearing Speed (mm/min)
5~35	45~85	860~1060	300

Application Notice

1. Storage Conditions :

To maintain the solderability of terminal electrodes :

- a) Recommended products should be used within 12 months from the time of delivery.
- b) The packaging material should be kept where no chlorine or sulfur exists in the air.

2. Transportation :

- a) Products should be handled with care to avoid damage or contamination from perspiration and skin oils.
- b) Vacuum pick is strongly recommended for individual components.
- c) Bulk handling should ensure that abrasion and mechanical shock are minimized.



RoHS Compliant

NOTE : Specifications subject to change without notice. Please check our website for latest information.

13.09.2016



SUPERWORLD ELECTRONICS (S) PTE LTD

PG. 8