

1. Part No. Expression:

**PDC1004100MZ F**

(a) (b) (c) (d)(e)(f)

- (a) Series Code
- (b) Dimension Code
- (c) Inductance Code
- (d) Tolerance Code
- (e) X,Y,Z : Standard Part
- (f) RoHS Compliant

2. Configuration & Dimensions :

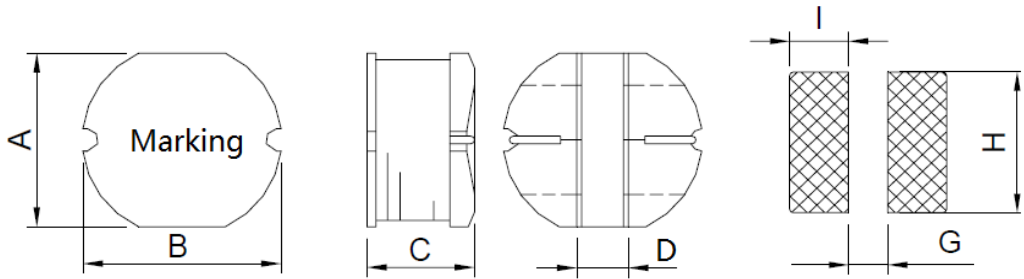

Recommended PC Board Pattern

Note:

- 1. Marking : Inductance code (refer table on next page)

Unit: mm

A	B	C	D	G	H	I
9.0±0.3	10.0±0.3	4.0±0.5	3.0±0.3	2.50 Ref.	9.50 Ref.	3.75 Ref.

3. Schematic

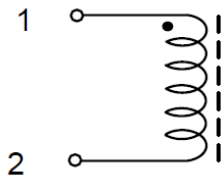

NOTE: Specifications subject to change without notice. Please check our website for latest information.

4. Material List

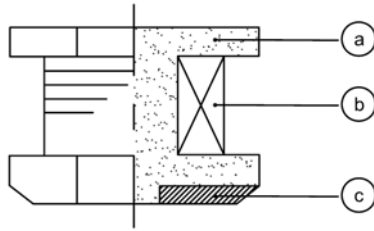

- a) Drum Core
- b) Wire
- c) Electrode

5. General Specification

- a) Operating Temperature: - 40°C to +125°C
- b) Storage Temperature: - 40°C to +125°C
- c) Humidity Range: 90 - 95% RH
- d) Heat Rated Current (Irms) will cause the coil temperature rise Δt of 40°C Max.
- e) Storage Condition (component in its packaging)
  - i) Temperature: Less than 60°C
  - ii) Humidity: ≤ 90%

6. Electrical Characteristics

Part Number	Inductance (uH)	Test Frequency (Hz)	DCR(mΩ) Max.	IDC(mA) Drop%	Part Marking
PDC1004100MZF	10	1V/2.52M	0.053	2.38	100
PDC1004120MZF	12	1V/2.52M	0.061	2.13	120
PDC1004150MZF	15	1V/2.52M	0.070	1.87	150
PDC1004180MZF	18	1V/2.52M	0.081	1.73	180
PDC1004220MZF	22	1V/2.52M	0.088	1.60	220
PDC1004270MZF	27	1V/2.52M	0.100	1.44	270
PDC1004330MZF	33	1V/2.52M	0.120	1.26	330
PDC1004390MZF	39	1V/2.52M	0.151	1.20	390
PDC1004470KZF	47	1V/2.52M	0.170	1.10	470
PDC1004560KZF	56	1V/2.52M	0.199	1.01	560
PDC1004680KZF	68	1V/2.52M	0.223	0.91	680
PDC1004820KZF	82	1V/2.52M	0.252	0.85	820
PDC1004101KZF	100	1V/1K	0.344	0.74	101
PDC1004121KZF	120	1V/1K	0.396	0.69	121
PDC1004151KZF	150	1V/1K	0.544	0.61	151
PDC1004181KZF	180	1V/1K	0.621	0.56	181

NOTE: Specifications subject to change without notice. Please check our website for latest information.

Part Number	Inductance (uH)	Test Frequency (Hz)	DCR(mΩ) Max.	IDC(mA) Drop%	Part Marking
PDC1004221KZF	220	1V/1K	0.721	0.53	221
PDC1004271KZF	270	1V/1K	0.949	0.45	271
PDC1004331KZF	330	1V/1K	1.100	0.42	331
PDC1004391KZF	390	1V/1K	1.245	0.38	391
PDC1004471KZF	470	1V/1K	1.526	0.35	471
PDC1004561KZF	560	1V/1K	1.904	0.32	561

Tolerance: K = ± 10% ; M = ± 20%

**7. Soldering:**

Recommended temperature profiles for re-flow soldering in Figure 1.

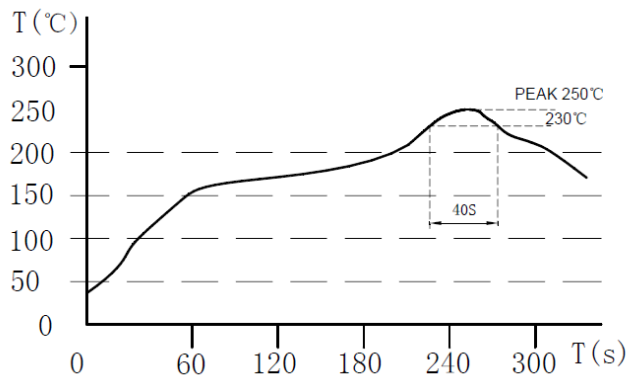

Figure 1: Reflow time: 2 times max

NOTE: Specifications subject to change without notice. Please check our website for latest information.



8. Packaging Information:

8-1 Reel Dimension:

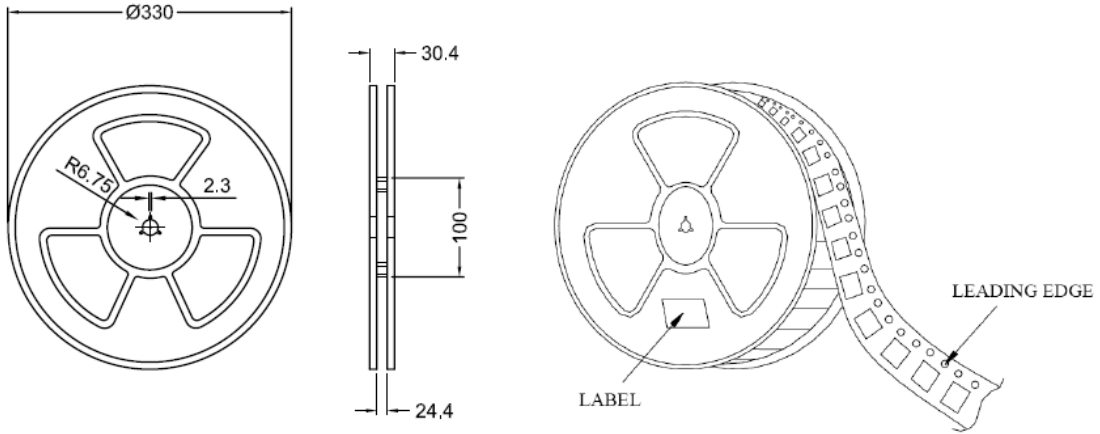

8-2 Tape Dimension:

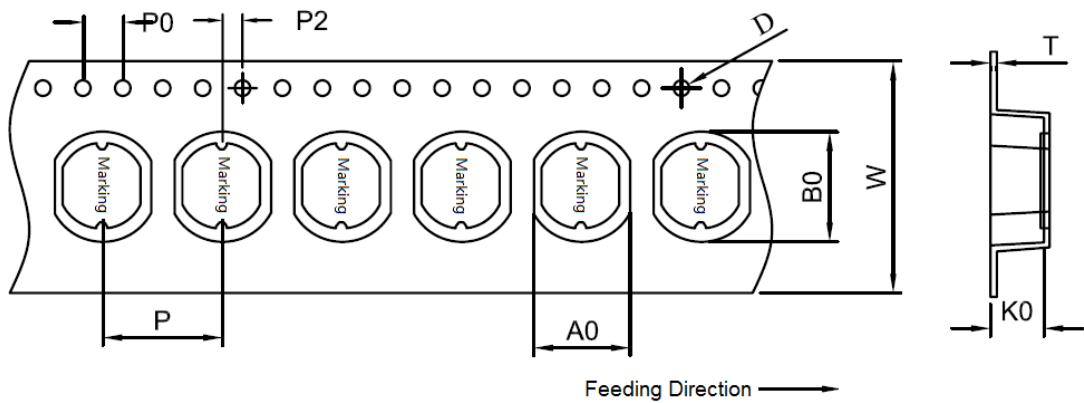

Bo(mm)	Ao(mm)	Ko(mm)	P(mm)	W(mm)	P0(mm)	P2(mm)	T(mm)	D(mm)
10.4±0.1	9.4±0.1	4.3±0.1	12.0±0.1	24.0+0.3/-0.1	4.0±0.1	2.0±0.1	0.35	1.5+0.1/-0

8-3 Packaging Quantity:

PDC	1004
Reel	1000
Carton	5000

NOTE: Specifications subject to change without notice. Please check our website for latest information.

## 8-4 Tearing Off Force:

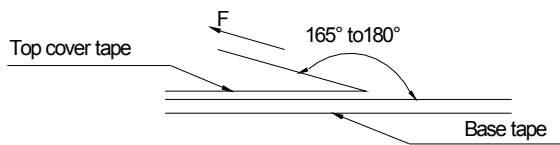

The force for tearing off cover tape is 0.1N to 1.3N in the arrow direction under the following conditions.

Room Temp. (°C)	Room Humidity (%)	Room atm (kPa)	Tearing Speed mm/min
15~35	25~85	86~106	300

## Application Notice:

### 1. Storage Conditions:

To maintain the solderability of terminal electrodes:

- a) Recommended products should be used within 6 months from the time of delivery.
- b) The packaging material should be kept where no chlorine or sulfur exists in the air.

### 2. Transportation:

- a) Products should be handled with care to avoid damage or contamination from perspiration and skin oils.
- b) Vacuum pick up is strongly recommended for individual components.
- c) Bulk handling should ensure that abrasion and mechanical shock are minimized.

NOTE: Specifications subject to change without notice. Please check our website for latest information.